

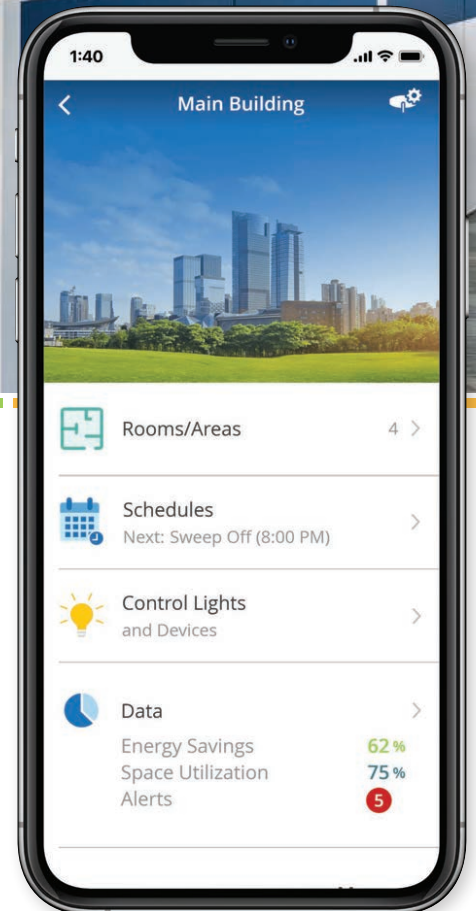

VIVE

Simple, scalable, wireless
lighting control

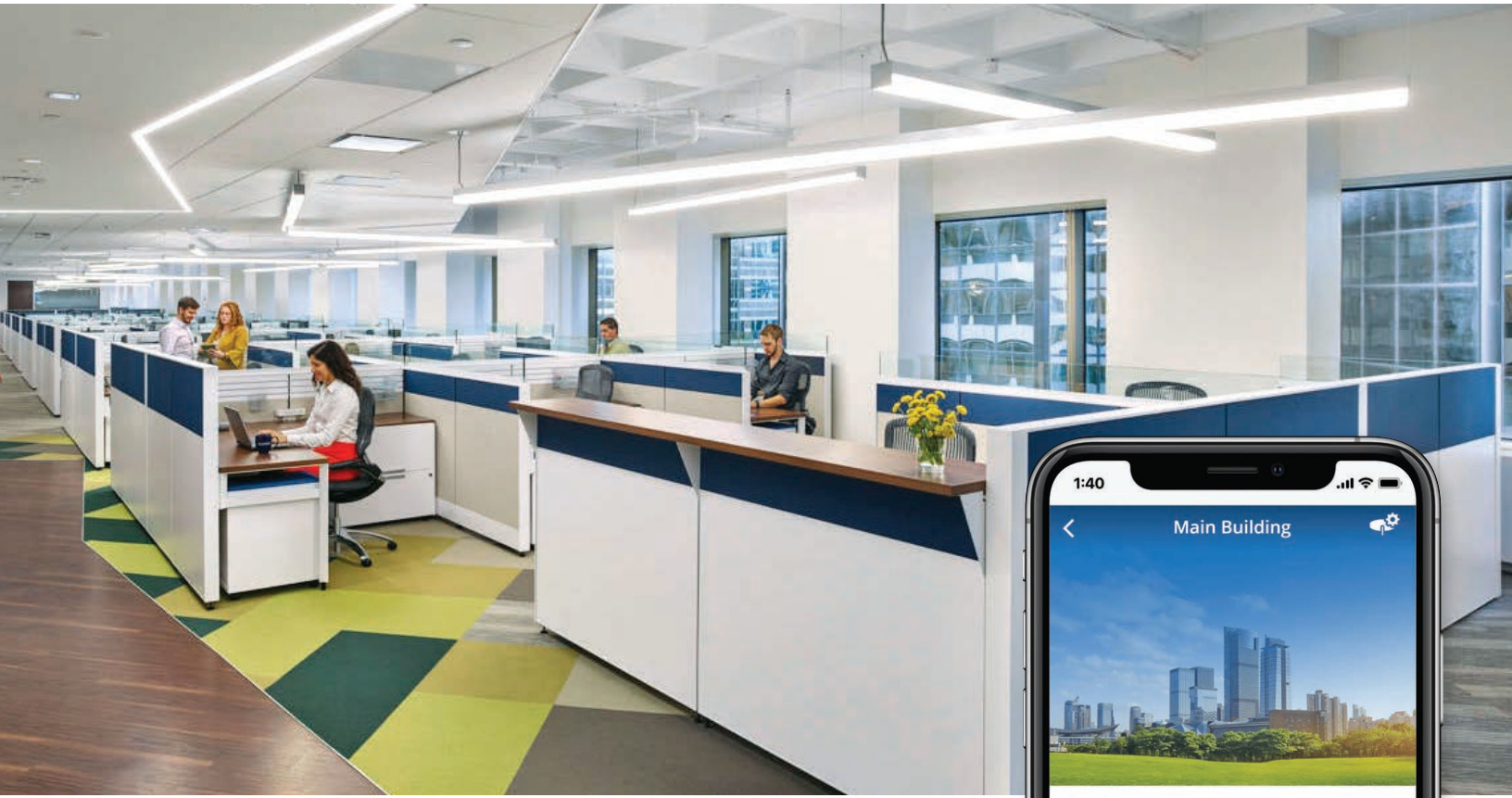

Flexible control every step of the way

A simple wireless lighting control solution
for new and existing commercial buildings.



How can you make every office, school, or university campus an efficient, comfortable and productive place to work or learn?

Vive is the answer.

Vive by Lutron is a simple, scalable, wireless control that can be installed in a single space or throughout an entire campus. It's designed to meet today's energy codes, be used in new construction or retrofit situations, and meet your budgetary needs.

And with a wide family of products – including sensors, remotes, load controllers, and an available software management suite – Vive provides the flexibility to select the products you want and handle any on-site challenges with ease.



Load Controllers



In-wall controls



Wireless remotes



Wireless Sensors



Integration

Vive Installation
Madison College — Madison, Wisconsin

Vive wireless solutions offer a multi-strategy approach that accommodates your budget and performance needs now, and for the future of your building.

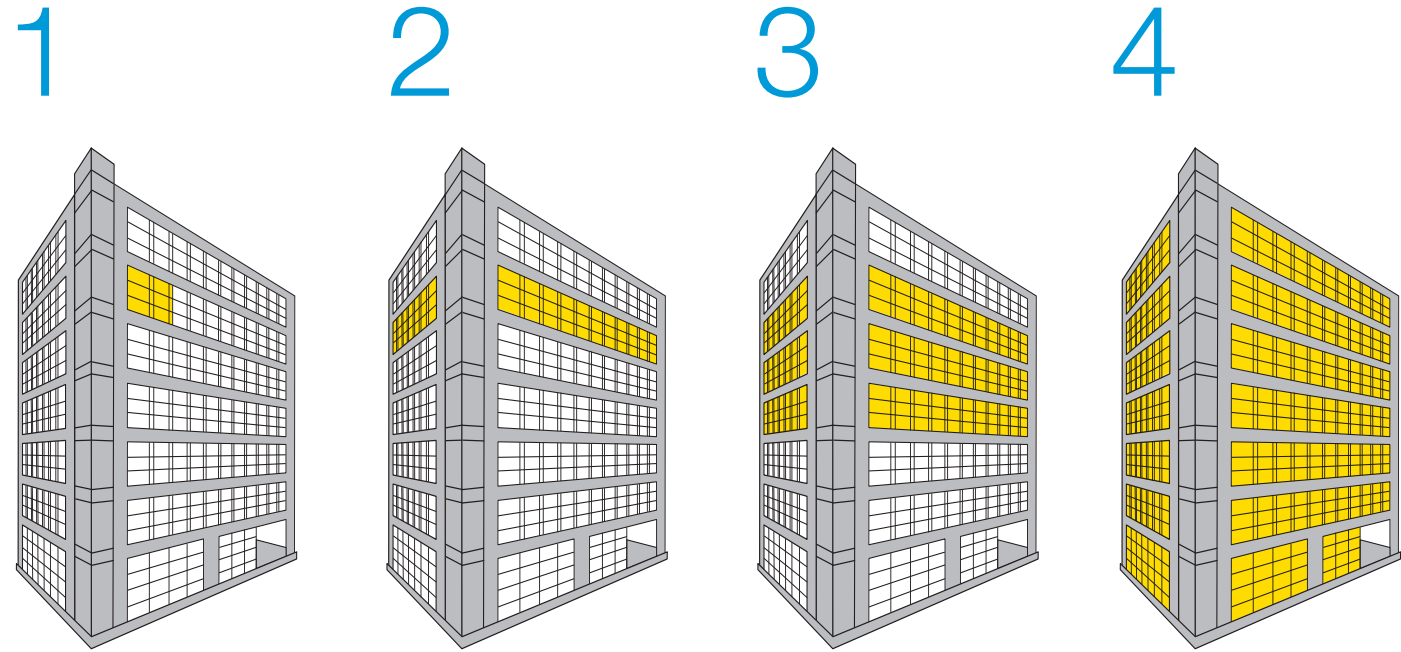

1
Single office space

Start by adding control in a single space and expand as budgets and occupant schedules allow.

2
Single floor

Expand to new areas or an entire floor at any time without reprogramming or replacing existing equipment.

3
Multiple floors

Duplicate the success of one floor across other floors as your business expands or tenants change. Control can be independent on each floor, or linked via Vive wireless hubs.

4
Entire building

Vive offers seamless integration to other building management systems to control every light in your building.

Combine lighting control strategies to maximize efficiency

What is the savings opportunity?

Lutron solutions can save 60%³ or more lighting energy.

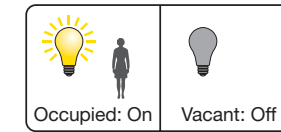

Occupancy/vacancy sensing turns lights on when occupants are in a space and off when they vacate the space.

Potential savings

20–60%
Lighting⁴

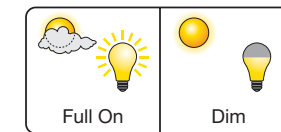

Daylight harvesting dims electric lights when daylight is available to light the space.

25–60%
Lighting⁵

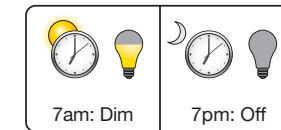

Scheduling provides pre-programmed changes in light levels based on time of day.

10–20%
Lighting⁶

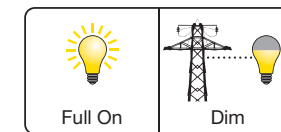

Demand response automatically reduces lighting loads during peak electricity usage times.

30–50%
Peak Period⁷

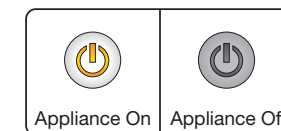

Plug load control automatically turns off loads after occupants leave a space.

15–50%
Controlled Load⁸

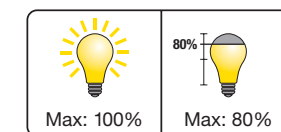

High-end trim sets the maximum light level based on customer requirements in each space.

10–30%
Lighting⁹

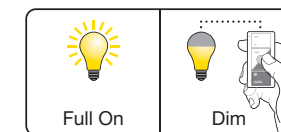

Personal dimming control gives occupants the ability to adjust the light level.

10–20%
Lighting¹⁰

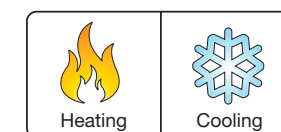

HVAC integration controls heating, ventilation, and air conditioning systems through contact closure, or BACnet protocol.

5–15%
HVAC¹¹

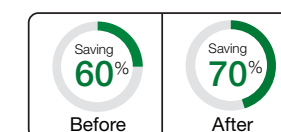

System Optimization Service from Lutron identifies important lighting control adjustments to save additional energy and create a more productive work environment on an ongoing basis.

Variable

Flexible, wireless controls and sensors for simple, code-compliant design

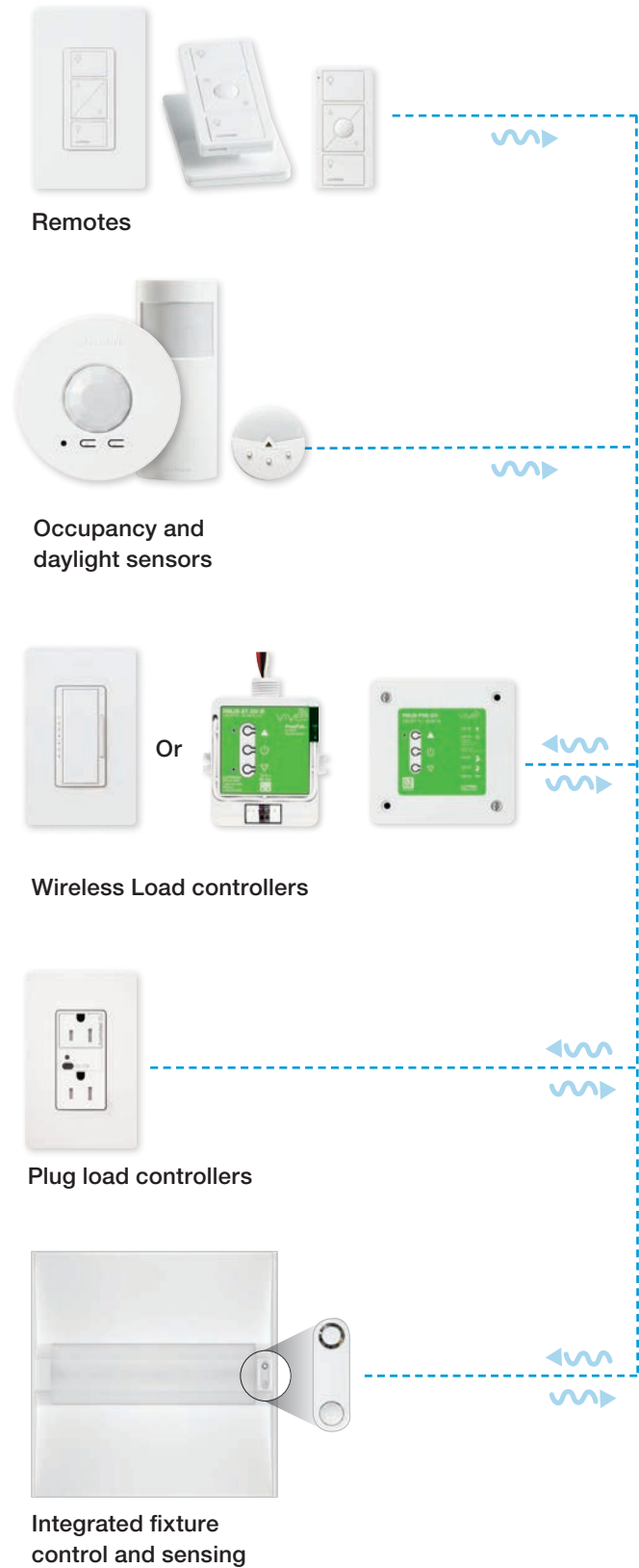

Add wireless hubs for centralized control and integration (optional)



Simple-to-use software

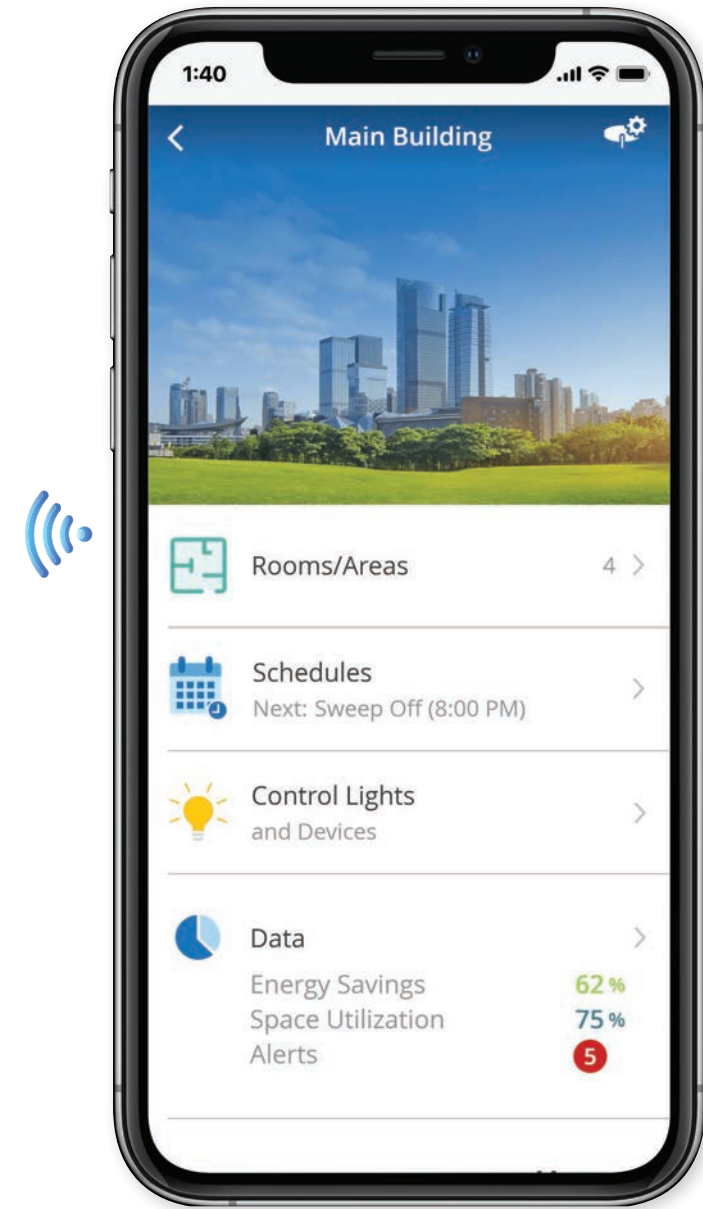

Vive software

Communication protocols



Communicate via RF to control components



Communicate via WiFi to smart devices



Communicate via wired Ethernet to Vive hub

Area Control

Step 1

Control your loads

- Select the controller appropriate for the loads on your job
- Options available for:
 - switching, 0-10V, phase dimming, Ecosystem, contact closure
- Simply wire one load controller for each group of lights you want to control together

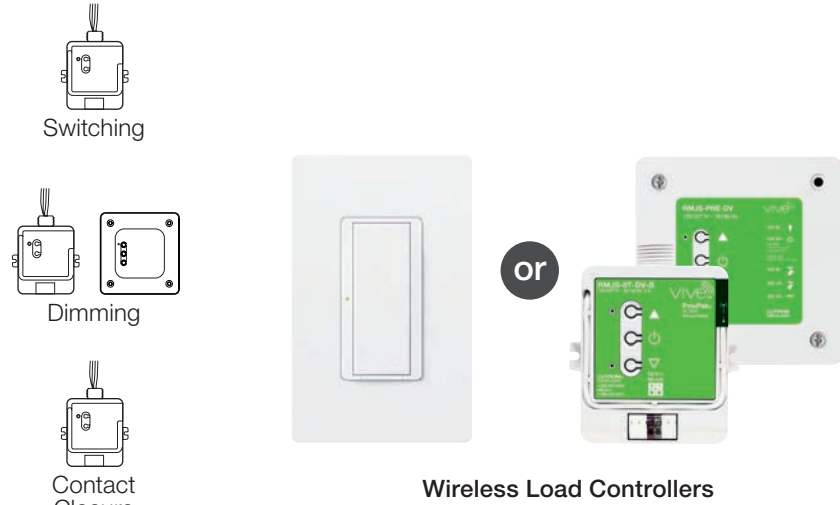

Step 2

Control your lights where you need to

- Wireless devices can be mounted to any surface with no wiring needed
- Controls communicate wirelessly to the controls in the ceiling
- 10-year battery life



Step 3

Add sensors to your job

- Occupancy/vacancy sensors turn lights on and/or off for convenience and energy savings
- Wireless devices can be mounted to any surface with no wiring needed
- Controls communicate wirelessly to the controls in the ceiling
- 10-year battery life

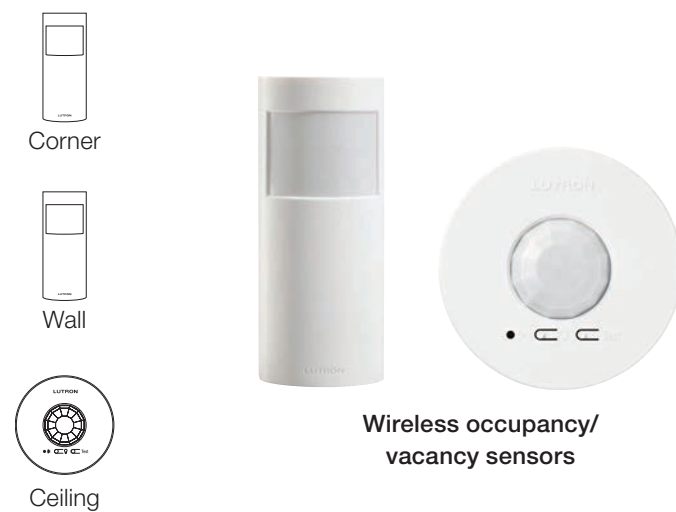

Area Control

Step 4

Add daylight harvesting to meet code and save energy

- Save energy by dimming the lights when natural light is available
- Wireless devices can be mounted to any surface with no wiring needed
- 10-year battery life



Daylight sensor



Step 5 (optional)

System software and control

- Timeclock
- Demand response
- BACnet & API integration
- Energy and Occupancy information
- Proactive maintenance alerts

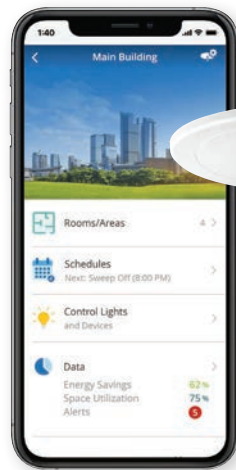

Vive Software

See easy programming setup

pages 16 – 17

Individual Fixture Control

Step 1

Simply count the fixtures—the technology is built in

- Visit lutron.com/hpfl for a list of fixtures that come with Vive wireless technology built in
- Fixture are shipped with occupancy, vacancy and daylight sensing already installed

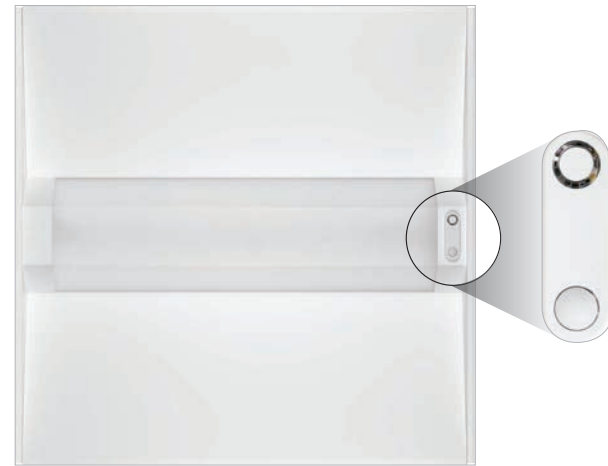

Occupancy/vacancy sensors



Step 2

Control your lights where you need to

- Wireless devices can be mounted to any surface with no wiring needed
- Controls communicate wirelessly to the controls in the ceiling
- 10-year battery life



Pico wireless remotes

Switching

Dimming

Scene

Step 3 (optional)

System software and control

- Timeclock
- Demand response
- BACnet & API integration
- Energy and Occupancy information
- Proactive maintenance alerts

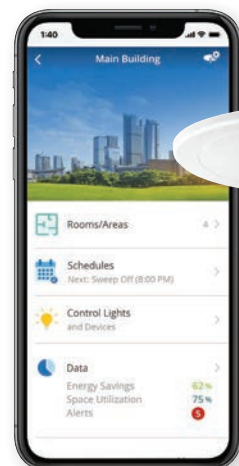

Vive Software

See easy system programming on pages 16 & 17

Access to tools and resources is at your fingertips.

Get access and quick answers keep your project moving.

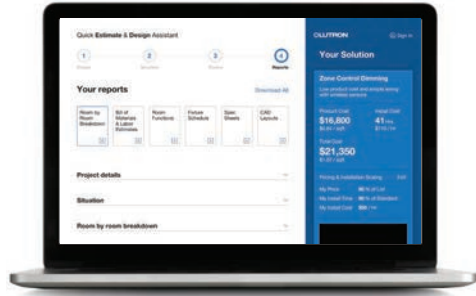

Free online estimating tool

Lutron QuEst-D is an easy-to-use software tool that gives you an estimate for your project based on a few simple questions. The result is an instant bill of materials that highlights details and ensures a code-compliant solution. Discover QuEst-D online at questd.lutron.com.



Easy-to-use design software

Lutron Designer+ for Vive is an intuitive, easy-to-use software tool that allows you to design a Lutron Vive lighting control system with visual “drag and drop” layout and connections. It also allows you to generate comprehensive system design documentation, including bills of materials, one-line diagrams, and sequence of operations. For access please contact myLutronsupport@lutron.com.



Quick help videos

Get access to Lutron Vive videos 24/7. Step-by-step setup, installation, and programming help whenever you need it. lutron.com/viveresources.

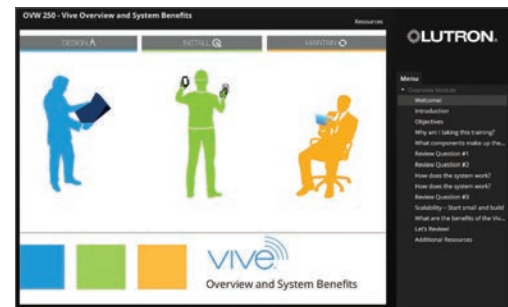

Online training

Visit lutron.com/LCIOOnline — Sign up for free, online training modules with practice exercises that walk you through the Vive system.

Summary of code requirements for lighting control

Vive wireless solutions ensure you can meet new construction and retrofit (lighting alterations¹²) code requirements for three major energy codes: ASHRAE, IECC, and Title 24¹³.

For specific commercial building code lighting requirements in your state, please visit lutron.com/energycodes.



App guides to help you meet codes

Codes can often be complicated and difficult to navigate. We have commercial application guides that include examples of different spaces and corresponding Lutron products for those spaces. Guides show you how you can use Lutron solutions to meet or exceed major energy code requirements.

Available online at lutron.com/appguides

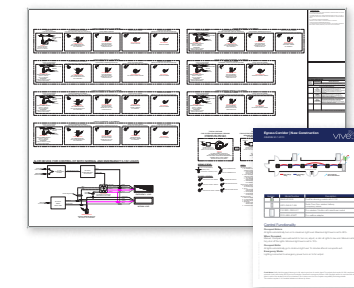

Vive wireless specification typicals

Specifying wireless lighting control reduces design time and allows flexibility for changes during the project without the need to redesign. Vive Wireless Specification Typicals allow for quick and easy design of many applications. Simply copy and paste the typicals into drawing packages for complete design, layout, and BOM information.

Available online at lutron.com/viveresources

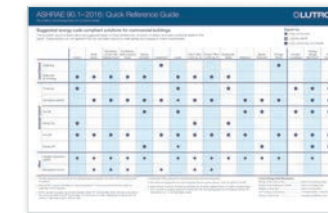

Energy code quick reference guides

Get the lighting and receptacle control requirements along with suggested functionality to meet the latest versions of ASHRAE 90.1, IECC, and Title 24 all on one page.

Available online at lutron.com/viveresources

Simple setup and programming options with the Vive wireless hub

Mobile phone setup

Using Vive software on any smart device you can wirelessly connect system controls and program system settings—no ladder required. Lutron's patent-pending RF signal strength detection automatically finds nearby devices, making job setup faster.

1 Press and hold on wireless device

2 Automatic fixture identification
Lutron patent-pending technology automatically finds and sorts the wireless devices closest to the control.



For systems without a Vive wireless hub

Push-button set up

Use simple button-press programming to select and associate wireless devices—it's as easy as setting a station on your car radio.



Wireless dimmer

Press and hold for 6 seconds



Occupancy sensor

Press and hold for 6 seconds
It works! Sensor now talks to the wireless dimmer



Energy savings and space utilization

Quickly view and display energy-usage information to drive decision making and demonstrate savings.

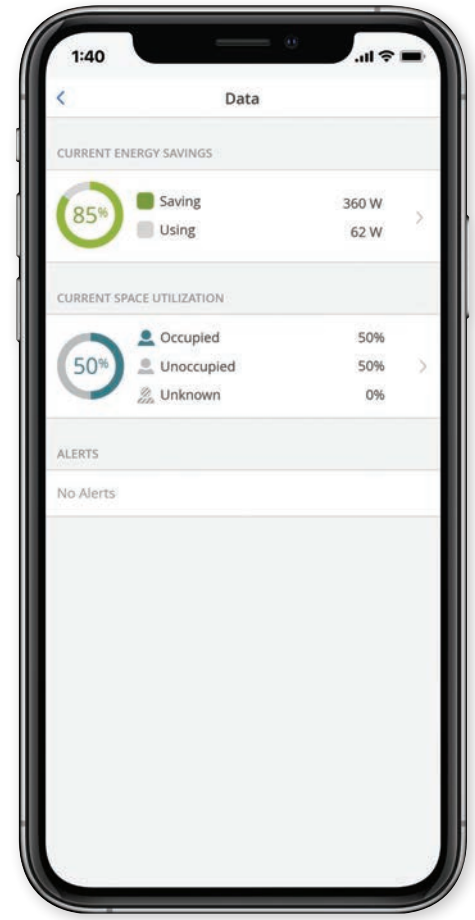

Load shed Open ADR Compatible

Easily set lighting reduction levels that automatically respond during peak electricity usage times.

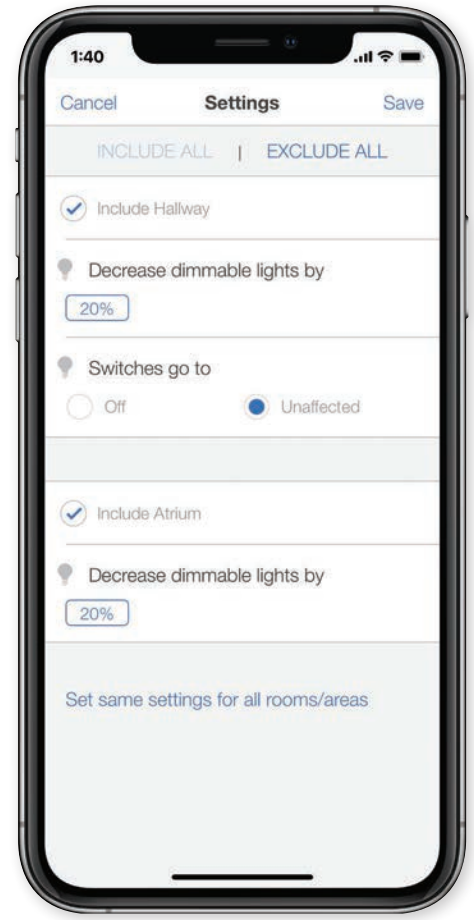

Schedules

Use a 365-day calendar to automatically adjust lights based on time of day, including single day and holiday events.

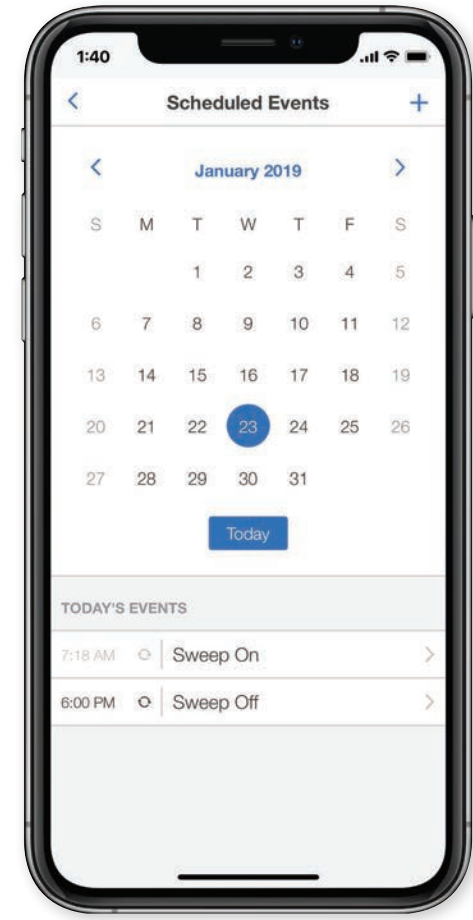

Scene Control

Create and configure scenes to control individual devices, areas, or groups of areas on demand.

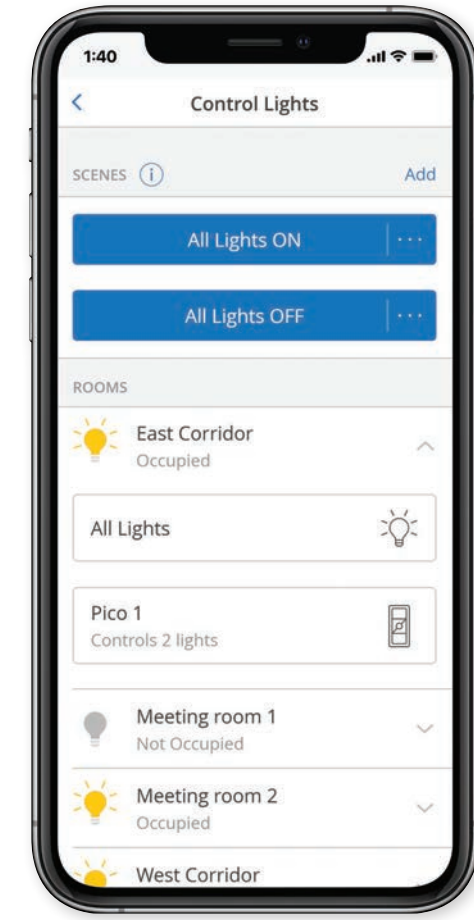

Light Control

Directly adjust the light levels remotely from any smart device. Easily respond to occupant requests without needing to be in the physical space.

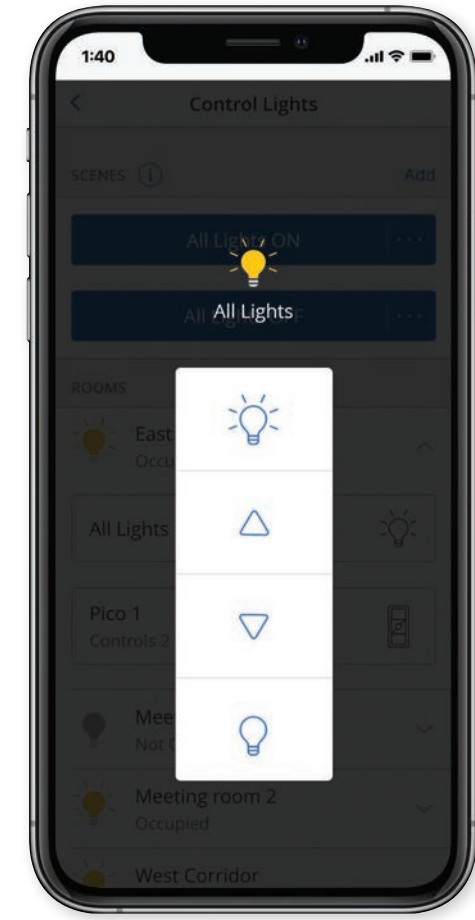

Alerts

View proactive alerts that show issues such as low batteries or inactive devices to help improve building maintenance efficiency.

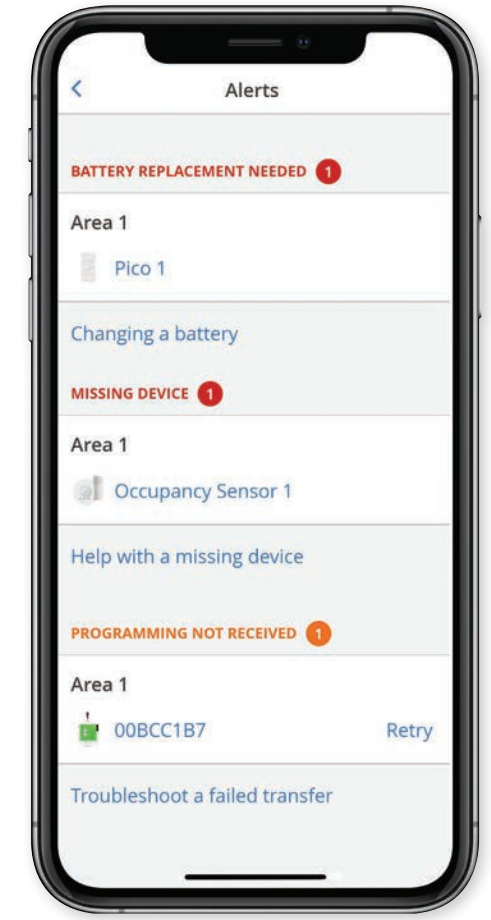

Seamlessly integrate with your building system

The BACnet/IP protocol is the primary means of integration. BACnet is embedded or native in the Vive wireless hub, which means no external interfaces or gateways are required in order to communicate with other systems.

API integration, native on the Vive hub, enables integration with third party devices, systems, and software. RESTful APIs are available over the ethernet.



+ Building/Energy Management Systems (BMS/EMS)

+ HVAC

+ Energy Dashboards and Analytics Packages

+ Audio & Video

+ API

+ IT

Vive Vue software

Vive Vue software now provides the ability to tie multiple Vive hubs together in one software interface. Built with the simple, scalable, wireless building blocks of the Vive Wireless system, Vive Vue software now delivers the advanced intelligence necessary for today's smart buildings and the IoT. A smart building is now easier than ever to achieve.



Intuitive control

View status, control lights, and optimize your building quickly and efficiently with a graphical floorplan.



Optimize your space

Improve building layout based on actual occupancy and usage information. With space utilization reports, you can quickly identify over-used and under-used spaces to improve building efficiency without expanding the building footprint.

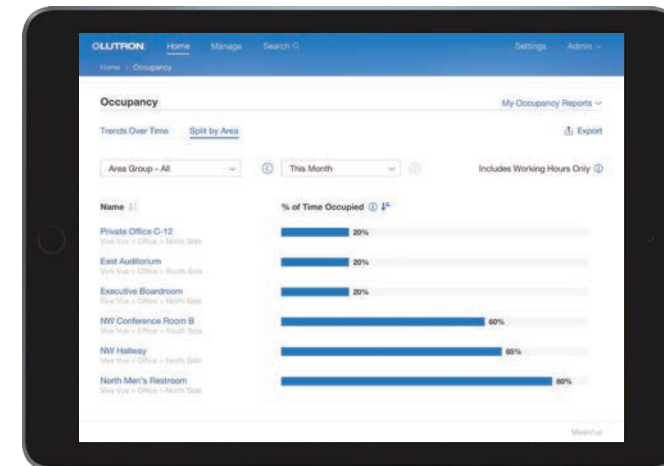

Save energy purposefully

Energy reports allow you to view and monitor your energy savings. With trending energy information over time, and easily customizable reports, Vive Vue software helps you demonstrate the energy-saving advantages of wireless lighting control.



Manage data and operations for multiple Lutron lighting and shade control solutions

- A single data and management platform for your connected buildings
- The system interface delivers a simple, consistent user experience from any PC or tablet
- Open, easy integration with BACnet and web APIs leverages the IoT to enhance smart-building performance

Enterprise Vue

limelight

limelight

VIVE

QUANTUM

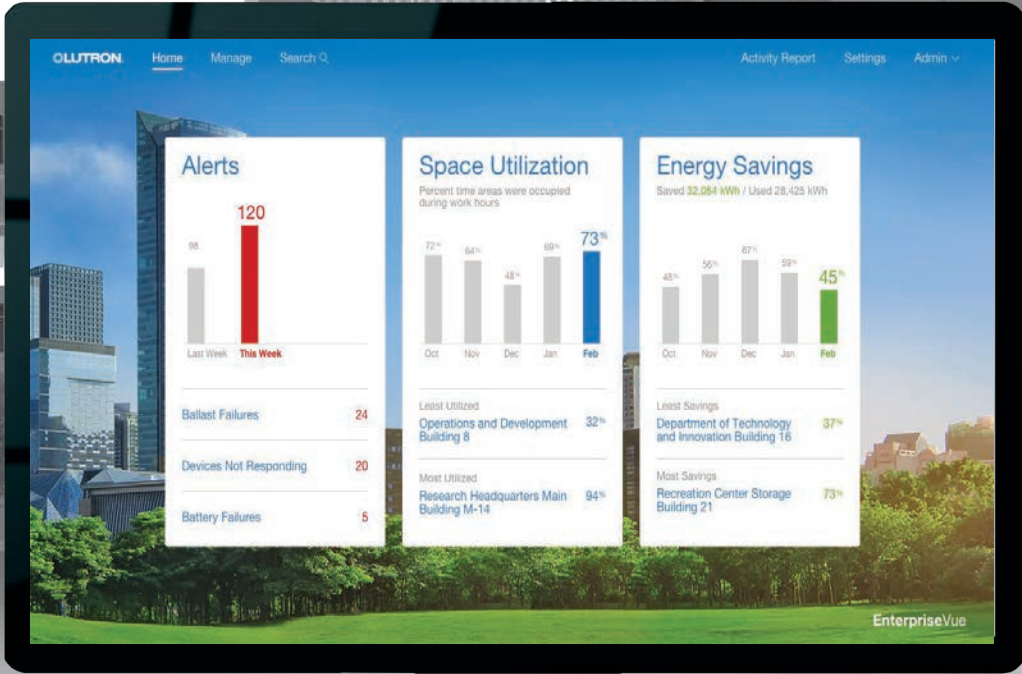

Enterprise Vue home screen



We build security into the product and the process from conception to installation, and through the lifetime of the system.

Everything we do is backed by Lutron’s first, and guiding, principle — Take Care of the Customer with Superior Goods and Services. Every product, every system, and every solution is designed, manufactured and tested to work as expected.

Security by design

When building any new system, Lutron utilizes a dedicated security team to ensure best practices are implemented. Security is built in. It is not an afterthought or add-on.

Examples of security features designed into Vive include:

1. Isolated wired and wireless architecture which strictly limits the possibility of the Vive Wi-Fi or Clear Connect being used to access the corporate network to gain confidential information
2. A distributed security architecture — each hub has its own unique keys
3. NIST-recommended best practices for securing passwords, including salting and use of SCrypt
4. AES 128-bit encryption for network communications
5. HTTPS (TLS 1.2) protocol for securing connections to the hub over the wired network
6. WPA2 technology for securing connections to the hub over the Wi-Fi network

Third-party validation

Security is complicated. Lutron has a dedicated team of internal experts, but we also leverage external experts to double- and triple-check our work.

1. Multiple external experts engaged during design process
2. Third-party penetration testing to identify and fix potential vulnerabilities before they reach the field

Continuous monitoring and improvements

Security is a constantly moving target. Lutron uses a dedicated security team to continuously monitor the market for potential threats and, when needed, send out security patches to update installed systems.

Ongoing support

Lutron has the resources you need to answer questions about security when they arise.

1. IT deployment guides
2. Guidance from our world class 24/7 technical support organization with IT expertise throughout the product lifecycle



Clear Connect wireless technology

All Lutron wireless products utilize Lutron patented Clear Connect wireless technology, which operates in an uncongested radio frequency band. The result is ultra-reliable communication and smooth dimming performance with no flicker or delay. Other devices will not interfere with the Lutron lighting control system.

Clear Connect

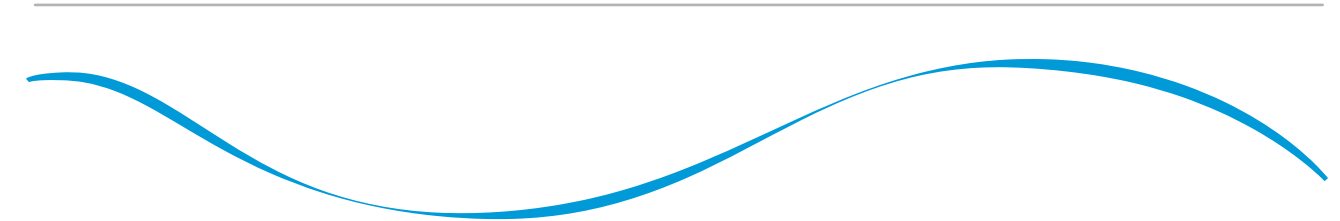

434 MHz: Lutron Clear Connect wireless technology

Lutron devices operate in an uncongested frequency band, providing ultra-reliable operation.



Other frequency bands

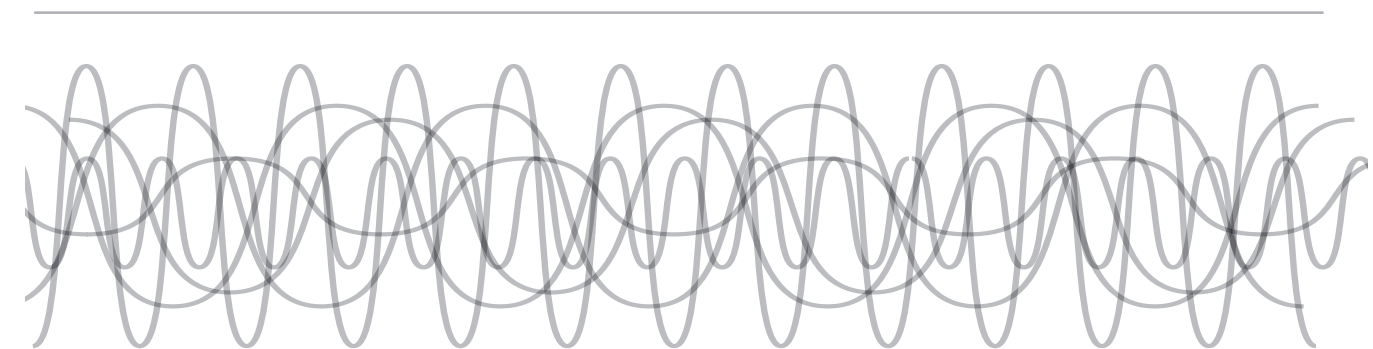

2.4 GHz: Cordless phones | Bluetooth devices | Wireless security cameras

Other devices operate in congested frequency bands, creating a high potential for wireless interference.



Wireless hub
page 28



Load Controllers
page 30



In-wall controls
page 44



Wireless remotes
page 48



Wireless Sensors
page 52

Vive Installation
Suncrest Bank — Visalia, California



Vive wireless hub

Dimensions

- W: 6.5" (165 mm)
- H: 1.5" (38 mm)
- D: 2.8" (71 mm)



Vive hub power supply

Dimensions

- W: 4.0" (102 mm)
- H: 1.7" (43 mm)
- D: 2.8" (71 mm)



Features and benefits

- Communicates with controls on a floor using Lutron wireless Clear Connect technology (range radius of 71 ft [22 m])
- Distributed system architecture
 - Pico remote controls and sensors communicate directly with the load devices they control and must be located within 30 ft (9 m) of the device with which they are associated
- Supports timeclock events based on both sunrise and sunset or fixed time-of-day
- Two contact closure inputs to enable load shed from other devices for Title 24 compliance and utility integration
- Open ADR 2.0b compatible for integration with utilities for demand response/loadshed and code compliance
- Each hub provides an individual dashboard for its coverage area and allows you to link to other hub dashboards from the mobile application
- API integration, native on the Vive hub, to enable integration with third party devices, systems, and software. RESTful APIs are available over the ethernet.
- Proactive alerts to inform batteries are low or devices may not be working to ensure system operates as expected.
- Override and lockout support for emergency devices to send the emergency lights to defined levels and lockout controls in the case of a fire alarm, power loss, or security incident. This may be activated manually or with an integration.

Product options

Vive wireless hub models

Starter (up to 75 devices)

HJS-0-FM	Flush mount
----------	-------------

Standard

HJS-1-FM	Flush mount
HJS-1-SM	Surface mount
H-MOUNT-SM	Surface-mount installation adapter

Premium (with BACnet and API)

HJS-2-FM	Flush mount
HJS-2-SM	Surface mount
HJS-UPDATE	Software upgrade license to add BACnet and API
HJS-DEVICES	Software upgrade license expands device limit to 700 devices

How it works

All wireless devices to be associated to the Vive wireless hub must be within 71 ft (22 m) of the Vive wireless hub and must be on the same floor as the Vive wireless hub.

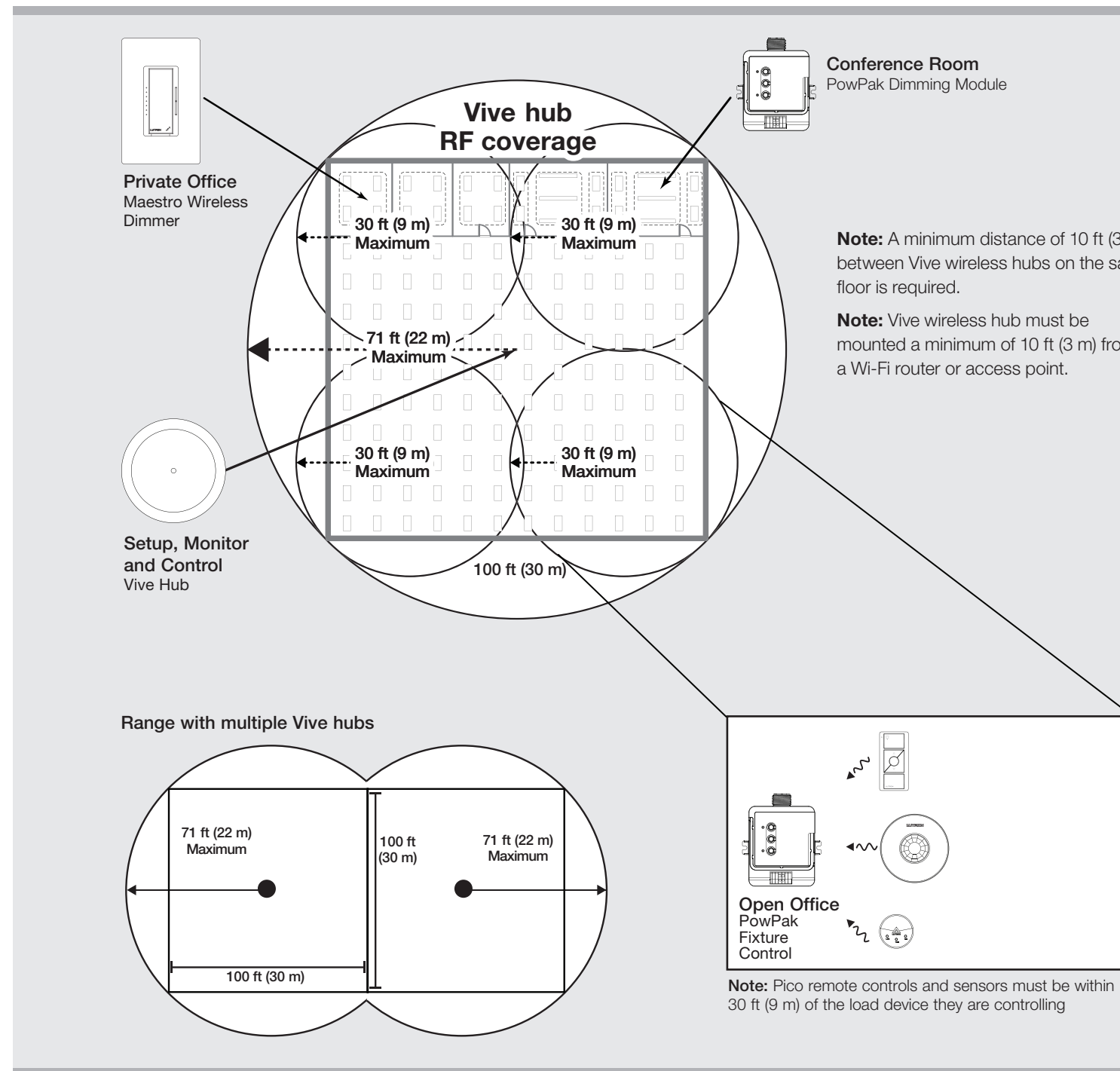

wireless hub



PowPak relay module

Dimensions

W: 2.89" (48mm)
 H: 3.44" (87mm)
 D: 1.25" (32mm)

How to design and specify

- **One relay module**
 For each controlled lighting zone in the space
- **Control**
 Select appropriate model based on the size of the connected load
 - 16A:** 1920W or 1/2 HP @ 120V or 4432W or 1 1/2 HP @ 277V
 - 5A:** 600W or 1/6 HP @ 120V or 1385W or 1/3 HP @ 277V
- **Contact closure output**
 For sending occupancy information to third-party equipment such as HVAC systems
- **Input** 120/277V

Product options

16A models

RMJS-16R-DV-B

RMJS-16RCCO1-DV-B One contact closure output

5A models

RMJS-5R-DV-B

RMJS-5RCCO1-DV-B One contact closure output



PowPak single zone EcoSystem/DALI

Dimensions

W: 2.89" (48mm)
 H: 3.44" (87mm)
 D: 1.25" (32mm)

How to design and specify

- **One single zone controller**
 For each EcoSystem/DALI lighting zone in the space
- **Control**
 EcoSystem/DALI: up to 32 drivers per controller
- Multiple drivers/balasts connected to control module will always work together as single zone
- **Input** 120/277V

Product options

EcoSystem single zone

RMJS-ECO32-SZ

How to design and specify

- **One dimming module with 0-10V control**
For each controlled 0-10V lighting zone in the space
- **Control**
8A: 0-10V controlled fixtures and switches compatible with third-party 0-10V fluorescent ballasts, LED drivers, and fixtures
- **Input** 120/277V
- **0-10V Link:** Communicates with up to 60 mA of fixtures

Product options

8A models with 0-10V control

RMJS-8T-DV-B

RMJS-8TN-DV-B



PowPak dimming module with 0-10V control

Dimensions

W: 2.89" (48 mm)
H: 3.44" (87 mm)
D: 1.25" (32 mm)

How it works

Two versions of the PowPak 0-10V are available that optimize for different wiring practices. The -8T model has a connector on the back of the box which is optimized for Class 2 wiring outside of the standard conduit. The -8TN model has the 0-10V wires coming out of the threaded end, optimized for wiring inside a junction box and used for when the 0-10V wires are run in the cable or conduit with the Class 1 wiring. Both versions can have the 0-10V control wires be installed using NEC® Class 1 or Class 2 wiring methods.

Wiring Schematic

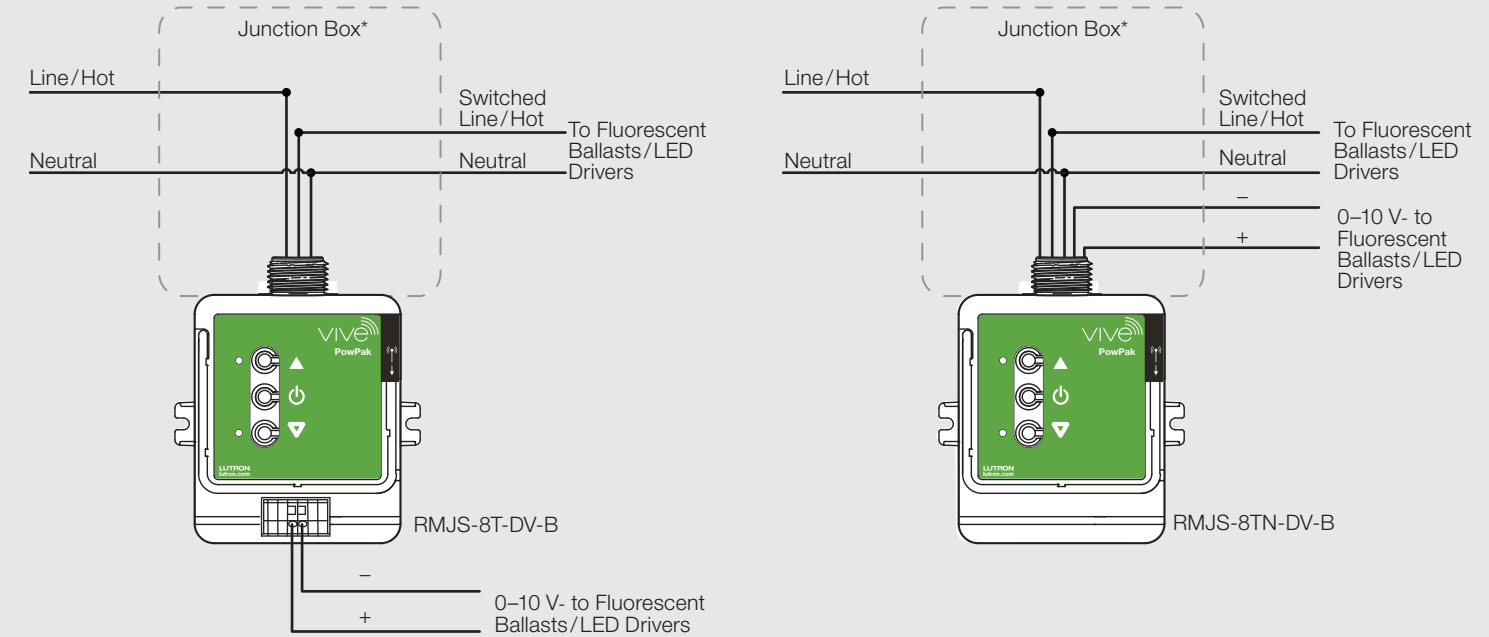

* **NOTE:** The control module mounts to the exterior of a U.S.-style junction box.



347V Dimming Module with 0-10V control

Dimensions

W: 4.53" (114.90 mm)
H: 4.53" (114.90 mm)
D: 1.80" (45.60 mm)

Mounting: Mounts in a standard 4 in x 4 in (101.6 mm x 101.6 mm) junction box. NOTE: Must use metal junction box, minimum depth 2.125 in (53.975 mm). Adding an extension ring is recommended for junction box depth extension. See Installation guide 048781 for additional information.

How to design and specify

- **One dimming module with 0-10V control**
 For each controlled 0-10V lighting zone in the space
- **Control**
- **5A:** 0-10V controlled fixtures and switches compatible with third-party 0-10V fluorescent ballasts, LED drivers, and fixtures
- **Input** 347V
- **0-10V Link:** Communicates with up to 60 mA of fixtures

Product options

5A model with 0-10V control

RMJS-5T-347

Divider for Class 1 & Class 2 Separation

5T-347-DIVIDER



450W/VA PowPak Phase Select dimming module

Dimensions

W: 4.53" (114.90 mm)
H: 4.53" (114.90 mm)
D: 1.80" (45.60 mm)

Mounting: Mounts in a standard 4 in x 4 in (101.6 mm x 101.6 mm) junction box. NOTE: Must use metal junction box, minimum depth 2.125 in (53.975 mm). Adding an extension ring is recommended for junction box depth extension. See Installation guide 048781 for additional information.

How to design and specify

- **One dimming module for Phase Control**
 For each controlled phase dimmable lighting zone in the space.
- **Control**
- LED drivers (reverse-phase) 450 VA
- Lutron Hi-lume 1% 2-wire LED driver A 3 A (13 drivers max)
- LED bulbs, self-ballasted lamps (reverse-phase) 450 VA
- LED NEMA SSL 7A-2015 (forward-phase) B, H 200 W
- Incandescent / halogen 450 W
- ELV (reverse-phase) 450 W
- Fluorescent (forward-phase) 400 VAF
- Neon / Cold Cathode, MLV C, D 400 VAF (320 W)
- **Input** 120V/277V

Product options

450W/VA PowPak Phase Select dimming module

RMJS-PNE-DV

Range Diagram

PowPak Module

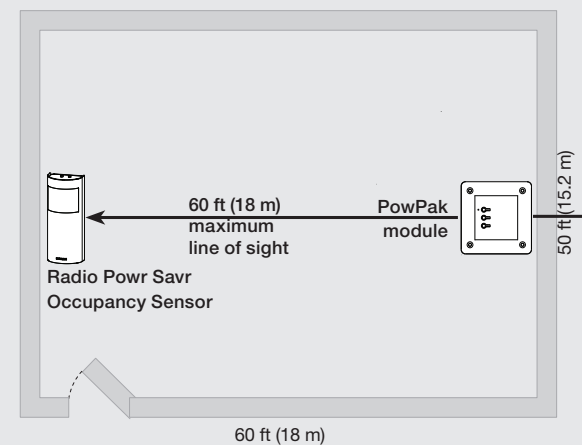

Contact Lutron first for applications using foil-backed or metallic ceiling tiles.

NOTE: Wireless sensors and controls must be located within 60 ft (18 m) line of sight, or 30 ft (9 m), through walls, of the associated control module. The 60 ft (18 m) range is not reduced by a ceiling tile obstruction.

Dimensions

Dimensions are shown as: in (mm)

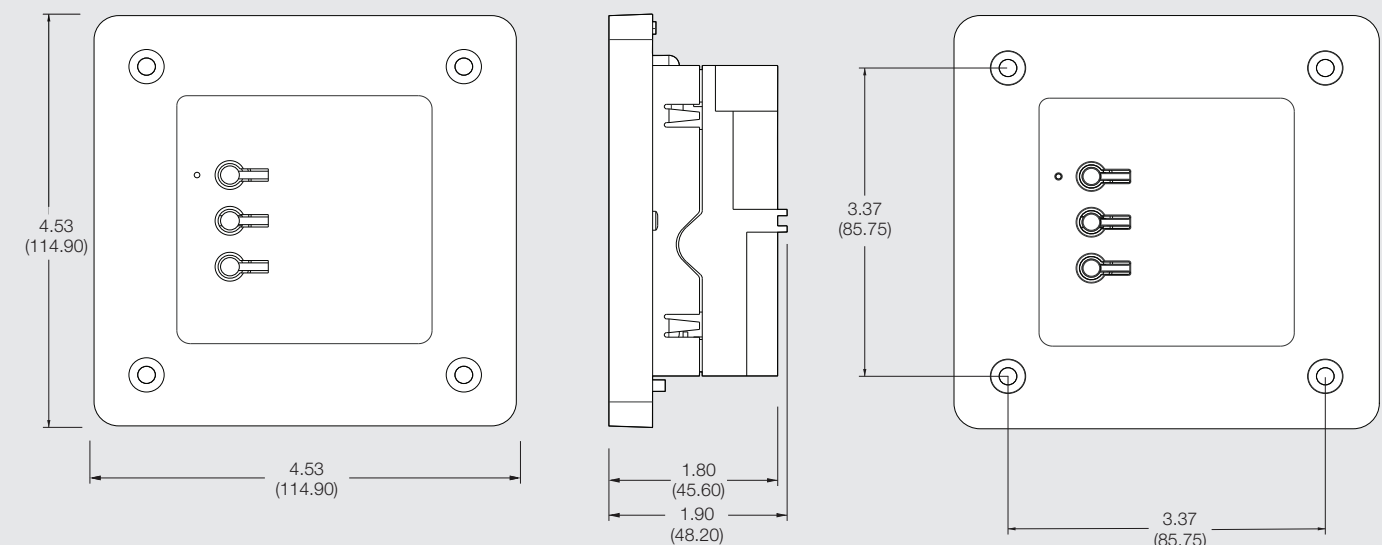

How to design and specify

- **One contact closure output module**
For each additional contact closure output you require

Product options

Standard

RMJS-CCO1-24-B Contact closure output

Note: If using a relay module with the contact closure output, you do not need to add a contact closure output module unless a second contact closure output is needed



PowPak contact closure output module

Dimensions

W: 2.89" (48 mm)
H: 3.44" (87 mm)
D: 1.25" (32 mm)

How it works

In response to information received from a Radio Powr Savr occupancy/vacancy sensor, the PowPak contact closure output module communicates room occupancy to the VAV terminal unit. By not heating or cooling an unoccupied room, the electricity consumed by the HVAC system can be reduced.

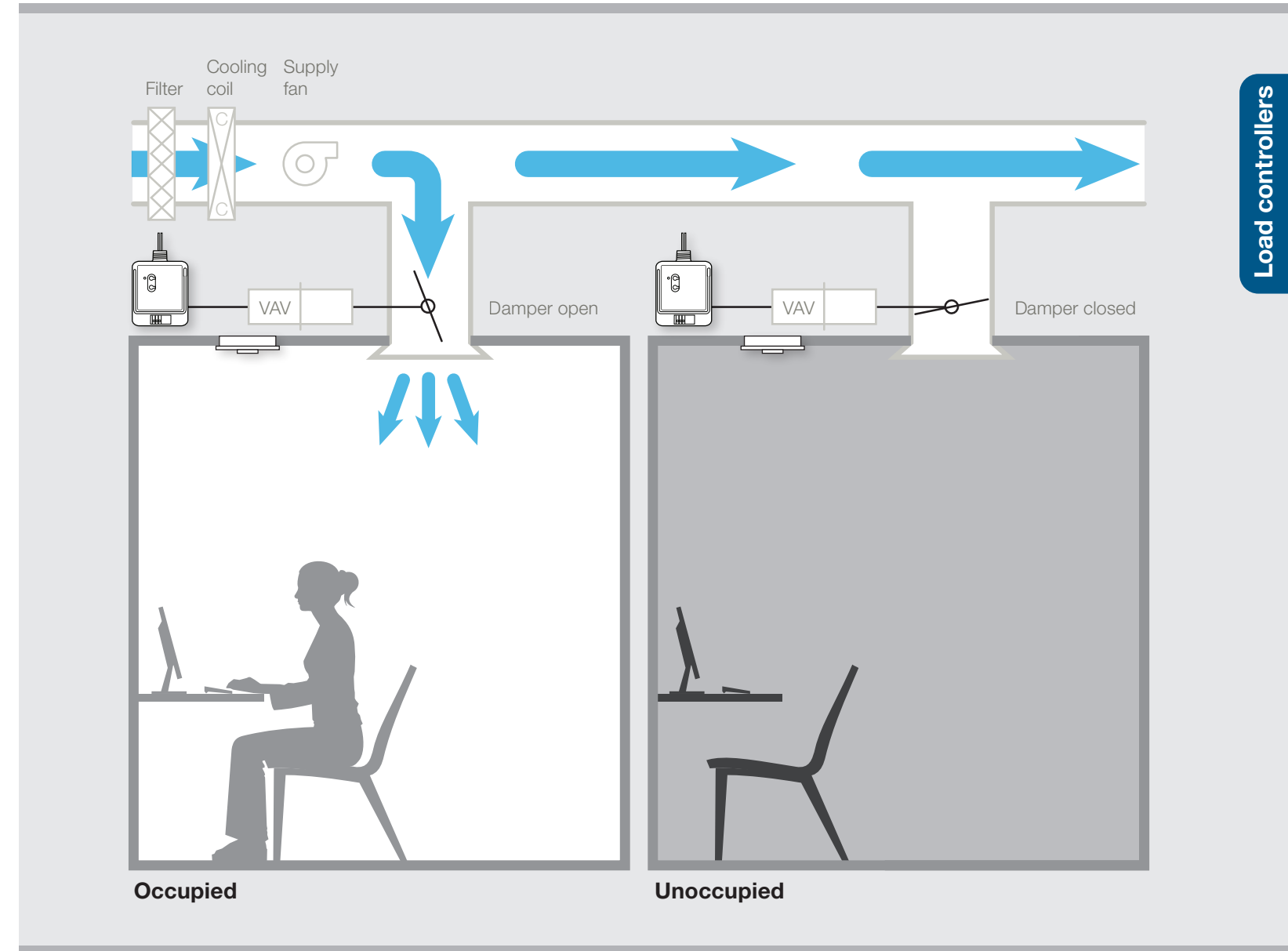

Radio Powr Savr occupancy/vacancy sensor (ceiling mount)



PowPak contact closure output module

How to design and specify

- **One relay module**
For each 20A receptacle circuit you want to control
- **Input** 120/277V

Product options

20 A models

RMJS-20R-DV-B	General purpose switch 120-277V receptacles
RMJS-20RCCO1-DV-B	General purpose switch 20A, 120-277V receptacles with one contact closure output



PowPak relay module

Dimensions

W: 2.89" (48 mm)
H: 3.44" (87 mm)
D: 1.25" (32 mm)

How it works

Plug loads, such as task lighting, computer monitors, and printers, account for greater than 5% of commercial electricity usage³. Many energy codes now require control of receptacles for compliance.

The occupancy/vacancy sensor wirelessly communicates room occupancy to the relay module. Based on the occupancy status received, the relay module switches the power to the receptacles on or off, reducing the amount of energy consumed.

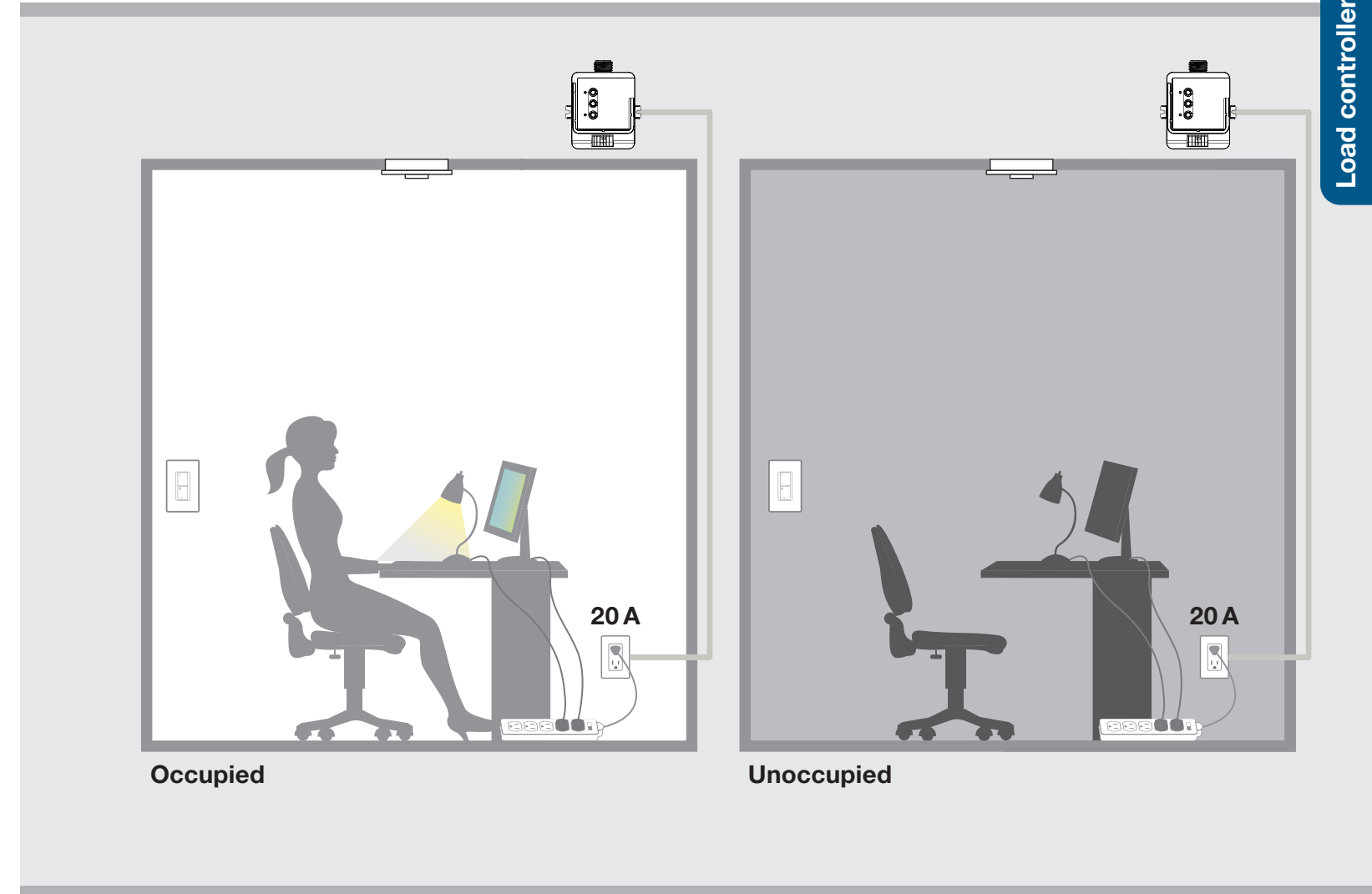

Radio Powr Savr occupancy/vacancy sensor (ceiling mount)



Pico control with wallplate



PowPak 20 A relay receptacle module



RF receptacle with top controlled

Dimensions

W: 2.94" (75mm)
 H: 4.69" (119mm)
 D: 1.4" (36mm)

How to design and specify

- **One wireless receptacle**
 For each receptacle circuit you want to control
 One wireless receptacle can also control standard receptacles wired downstream
- **Input 120V**

Product options

15A models

CAR2S-15-STR - 15A	Split (half switching; single pole/downstream)
CAR2S-15-DTR - 15A	Duplex (dual switching; single pole/downstream)

20A models

CAR2S-20-STR - 20A	Split (half switching; single pole/downstream)
CAR2S-20-DTR - 20A	Duplex (dual switching; single pole/downstream)

How it works

Plug loads, such as task lighting, computer monitors, and printers, account for greater than 5% of commercial electricity usage³. Many energy codes now require control of receptacles for compliance.

The occupancy/vacancy sensor wirelessly communicates room occupancy to the wireless receptacle. Based on the occupancy status received, the wireless receptacle switches the power on or off, reducing the amount of energy consumed. The wireless receptacle will control normal receptacles downstream.



Load controllers



Radio Powr Savr occupancy/vacancy sensor (ceiling mount)



Pico control with wallplate



RF receptacle with top control

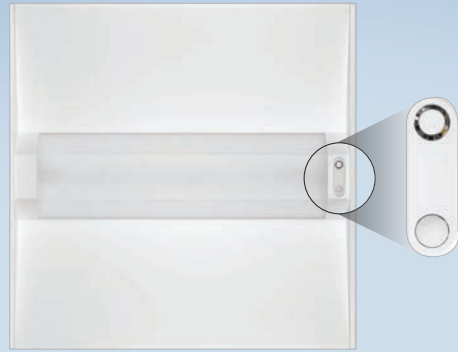

Vive Integral Fixture Control

Dimensions

W: .827" (21 mm)
H: 2.477" (62.9mm)

Dimensions with Occupancy/Daylight Sensor

W: .927" (23.5mm)
H: 2.577" (65.4mm)

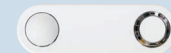

Clear Connect (RF) + Sensing

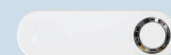

Clear Connect (RF) Only

How to design and specify

- **Vive integral fixture control**
For each fixture in the space
- **Digitally controls** up to three drivers/ballasts per fixture
- **Select either** Clear Connect (RF) only or Clear Connect (RF) & XCT Sensing

Product options

Wireless individual in-fixture control

DFCSJ-OEM-RF	Clear Connect (RF) only
DFCSJ-OEM-OCC	Clear Connect (RF) and Occupancy/Daylight Sensing

Contact your local fixture representative and ask for a Vive-enabled fixture or visit lutron.com/findafixture

Note: Wireless sensors and controls must be located within 60 ft (18 m) line of sight, or 30 ft (9 m) through walls of each other.



Vive Wireless fixture controller

Sensor Dimensions

W: 2.89" (48 mm)
H: 3.44" (87 mm)
D: 1.25" (32 mm)

How it works

Install the fixture control directly to a fixture or on a junction box nearest to the fixture. Install the sensor on the ceiling near the fixture to optimize coverage in the desired area.

Note: Avoid mounting the fixture sensor in direct sunlight or in the light which is cast from the fixture.

How to design and specify

- **One PowPak wireless fixture control**
For each fixture in the space
- **Controls** 1A of lead or up to three drivers/ballasts/per fixture
- **Select either** Area sensing or individual fixture sensing
- **PowPak fixture sensor** Combined occupancy/daylight sensor

Product options

0-10V control models

FCJS-010	
FCJS-010-BULK8	8-pack

EcoSystem control models

FCJS-ECO	
FCJS-ECO-BULK8	8-pack

Sensor models

FC-SENSOR	Occupancy/Daylight sensor
FC-VSENSOR	Vacancy/Daylight sensor

Fixture sensor coverage diagrams

Applies to both products

Clear Connect (RF)

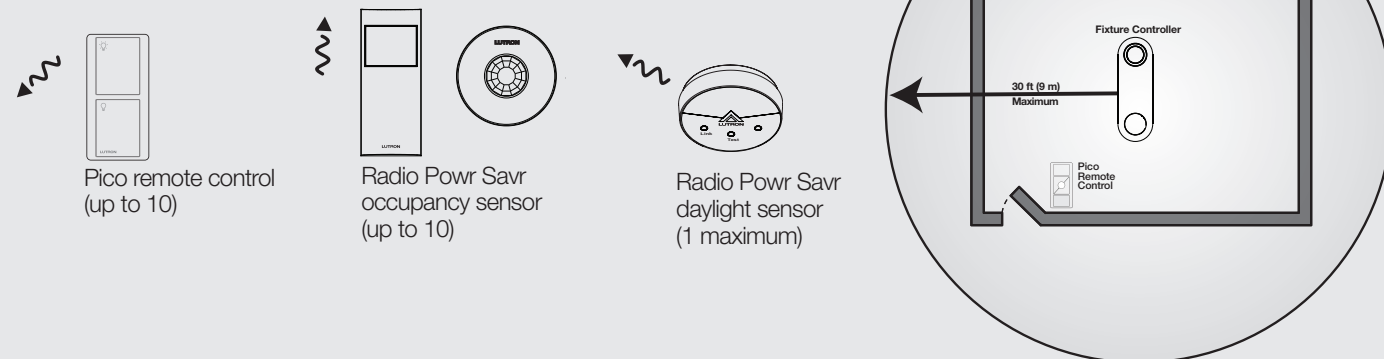

XCT Occupancy/Vacancy sensing

Range Diagrams

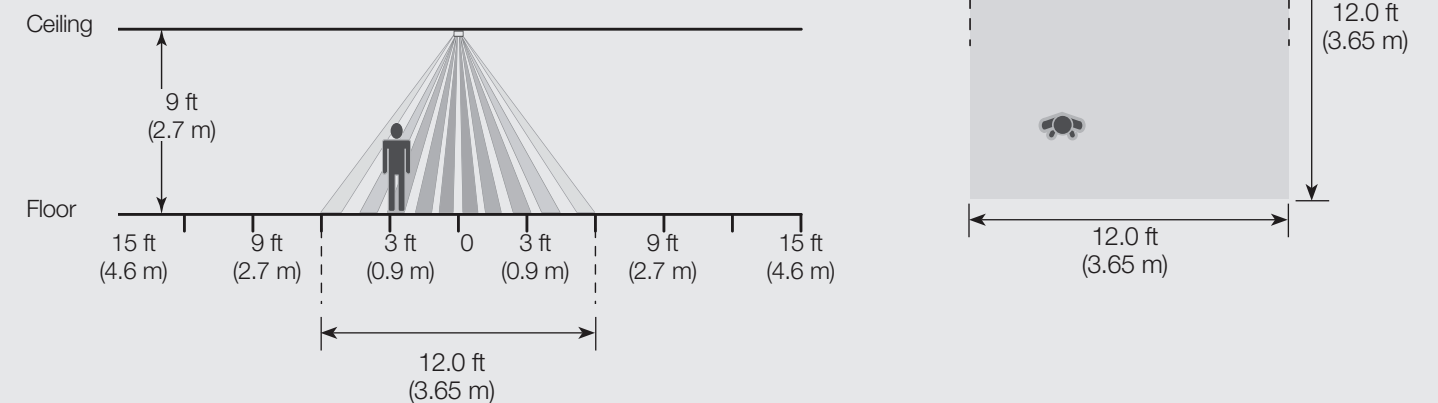



PowPak UL 924 emergency lighting modules

Dimensions

- W: 2.89" (48 mm)
- H: 3.44" (87 mm)
- D: 1.25" (32 mm)

UL 924 listed

How to design and specify

- One UL 924 PowPak module per lighting zone or fixture, depending on model

Relay module control:

- 16A: 1920W or 1/2 HP @ 120V
4432W or 1/2 HP @ 277

0-10V module control:

- 8A: 0-10V controlled fixtures and switches compatible with third-party 0-10V fluorescent ballasts, LED drivers, and fixtures
- 0-10V link: Communicates with up to 60 mA of fixtures

Fixture control:

- 1 A of load or up to 3 drivers and ballasts

- **Input (all models)** 120/277 V

Product options

Relay	RMJS-16R-DV-B-EM
0-10V	RMJS-8T-DV-B-EM
Fixtures	FCJS-010-EM FCJS-ECO-EM

How it works

During normal power conditions, the UL 924 rated PowPak modules can dim loads and respond to local button presses, Pico wireless controls, and occupancy/daylight sensors.

If utility power fails and the emergency PowPak loses power for greater than 250 msec, the emergency generator back-up source activates and the automatic transfer switch senses loss of normal power and switches to emergency power.

The emergency PowPak regains power and automatically goes into emergency mode (full output, relay closed and 0-10V signal goes to 10.0 V) for 90 minutes. All local buttons, Pico wireless controls and occupancy/daylight sensors will not respond.

When normal power is restored to the Vive hub and emergency PowPak, the emergency PowPak will return to the previous light level within 2 minutes of normal power being restored. It will again accept local button control, input from Pico wireless controls, and occupancy/daylight sensors.

System Wiring Diagram (Vive Hub with Emergency PowPak)

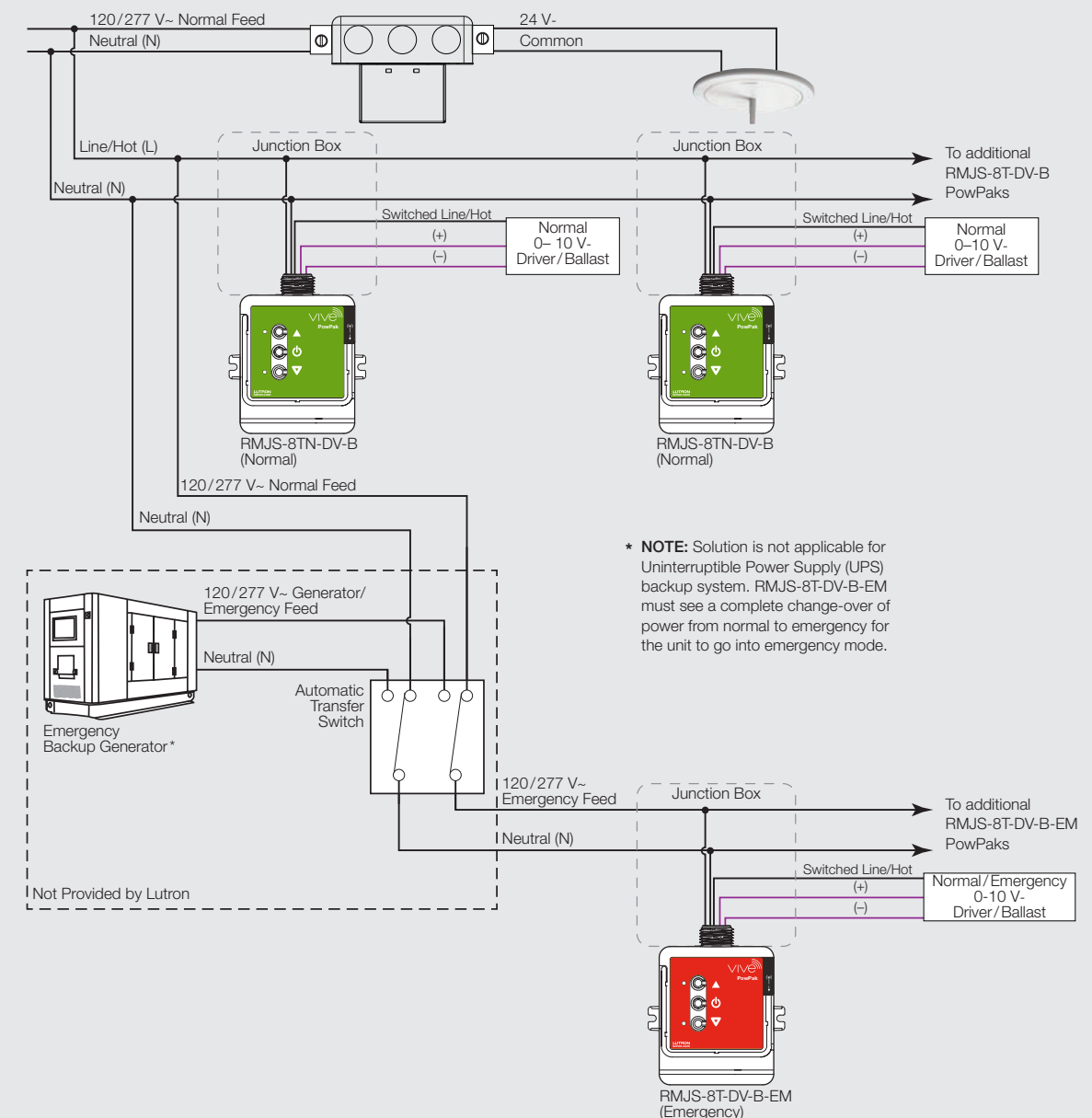



347 V emergency lighting module

Dimensions

- W:** 4.53" (114.90 mm)
- H:** 4.53" (114.90 mm)
- D:** 1.80" (45.60 mm)

Mounting: Mounts in a standard 4 in x 4 in (101.6 mm x 101.6 mm) junction box. NOTE: Must use metal junction box, minimum depth 2.125 in (53.975 mm). Adding an extension ring is recommended for junction box depth extension. See Installation guide 048781 for additional information.

How to design and specify

- One CSA C22.2 No. 141-15 Listed dimming module with 0-10V control per lighting zone
- **0-10V module control:**
- 5A: 0-10V controlled fixtures and switches compatible with third-party 0-10V fluorescent ballasts, LED drivers, and fixtures
- **0-10V Link** Communicates with up to 60 mA of fixtures
- **Input** 347V

Product options

5 A model with 0-10V control

RMJS-5T-347-EM



450W/VA Emergency PowPak Phase Select dimming module

Dimensions

- W:** 4.53" (114.90 mm)
- H:** 4.53" (114.90 mm)
- D:** 1.80" (45.60 mm)

Mounting: Mounts in a standard 4 in x 4 in (101.6 mm x 101.6 mm) junction box. NOTE: Must use metal junction box, minimum depth 2.125 in (53.975 mm). Adding an extension ring is recommended for junction box depth extension. See Installation guide 048781 for additional information.

How to design and specify

- **One dimming module for Phase Control**
For each controlled phase dimmable lighting zone in the space.
- **Control**
- LED drivers (reverse-phase) 450 VA
- Lutron Hi-lume 1% 2-wire LED driver A 3 A (13 drivers max)
- LED bulbs, self-ballasted lamps (reverse-phase) 450 VA
- LED NEMA SSL 7A-2015 (forward-phase) B, H 200 W
- Incandescent / halogen 450 W
- ELV (reverse-phase) 450 W
- Fluorescent (forward-phase) 400 VAF
- Neon / Cold Cathode, MLV C, D 400 VAF (320 W)
- **Input** 120V/277V

Product options

450W/VA Emergency PowPak Phase Select dimming module

RMJS-PNE-DV-EM

How it works*

During normal power conditions, the rated modules can dim loads and respond to local button presses, Pico wireless controls, and occupancy/daylight sensors.

If utility power fails and the emergency module loses power for greater than 1 sec, the emergency generator backup source activates and the automatic transfer switch senses loss of normal power and switches to emergency power.

The emergency module regains power and automatically goes into emergency mode (full output, relay closed and 0-10V signal goes to 10.0 V) for 120 minutes. All local buttons, Pico wireless controls and occupancy/daylight sensors will not respond.

When normal power is restored to the Vive hub and emergency module, the emergency module will return to the previous light level within 3-10 minutes of normal power being restored. It will again accept local button control, input from Pico wireless controls, and occupancy/daylight sensors.

System Wiring Diagram (Vive Hub with 347V Emergency Dimming Module)

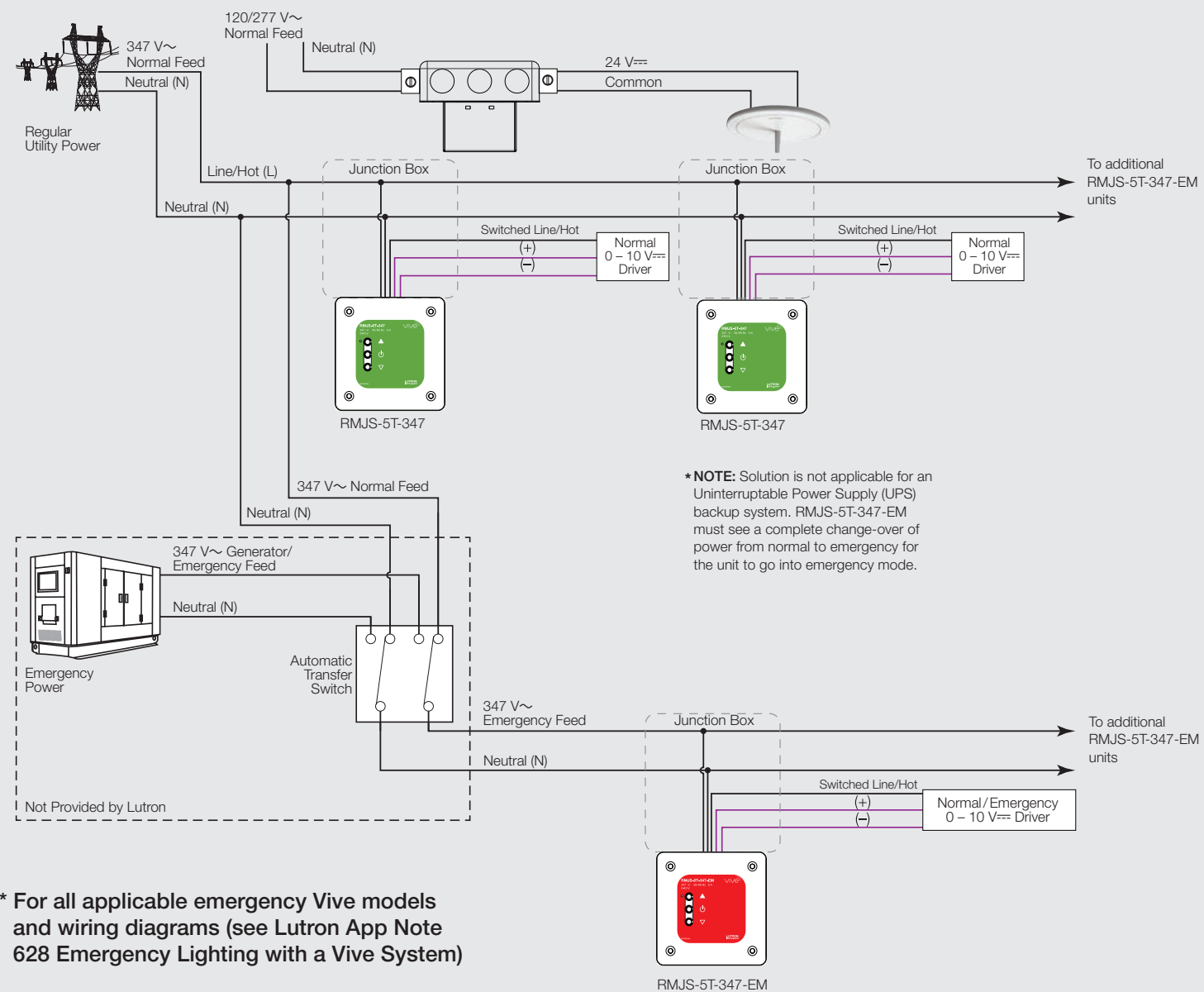

* For all applicable emergency Vive models and wiring diagrams (see Lutron App Note 628 Emergency Lighting with a Vive System)

Wiring Schematic

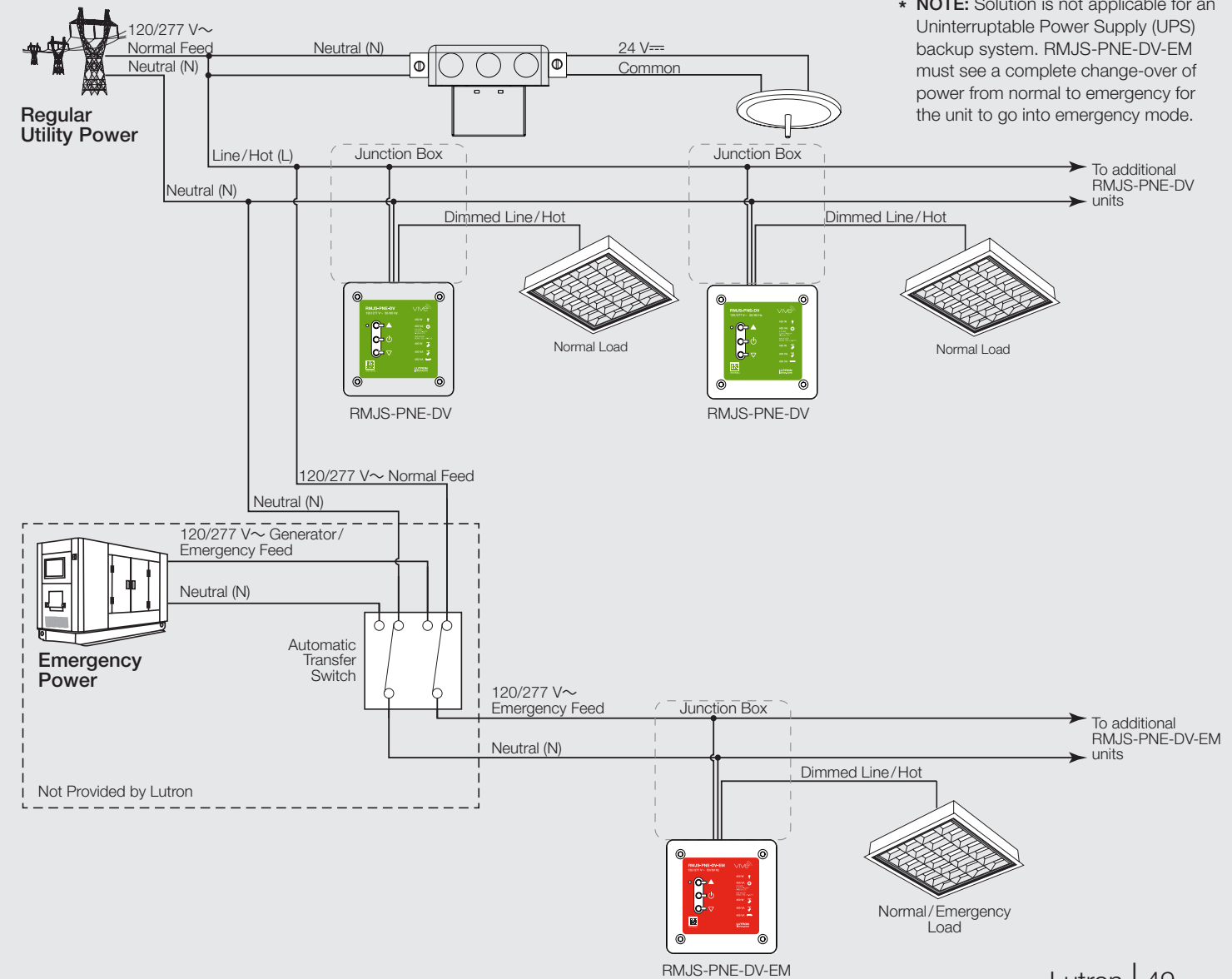



Maestro wireless switches

Dimensions

W: 2.94" (75mm)
H: 4.69" (119mm)
D: 1.44" (38mm)

How to design and specify

- Select one switch per lighting zone
- Select appropriate model based on the size of the connected load
 - **6A:** 600 W lighting @ 120V
 - **8A:** 960 W lighting @ 120V or 2216 W @ 277V
- If existing switch does not have a neutral, choose the model available for 120/277V with no neutral required
- Select from up to 27 colors to complement the décor*
- Add an additional Pico remote for rooms with multiple switches for a single zone

Product options

Dual Voltage No Neutral switches

MRF2S-8S-DV-XX	8 A lighting, 1/10 HP fan @ 120V only, 120-277 V, no neutral
-----------------------	--

120V Neutral required switches

MRF2S-6ANS-XX	6 A lighting, 1/10 HP fan, 120V only
MRF2S-8ANS-120-XX	8 A lighting, 1/4 HP fan, 120V only



Maestro wireless dimmers

Dimensions

W: 2.94" (75mm)
H: 4.69" (119mm)
D: 1.44" (38mm)

How to design and specify

- Select one wireless dimmer per lighting zone
- Select appropriate model based on the size and type of existing load
- Most models do not require a neutral
- Select from up to 27 colors to complement the décor*
- Add an accessory dimmer or a Pico wireless remote for rooms with multiple switches for a single zone
- Gray models (-GR) are plenum rated for mounting in ceiling applications

Product options

Maestro Wireless dimmers

MRF2S-6CL-XX	150 W dimmable CFL/LED, 600 W incandescent/halogen
MRF2S-6ELV120-XX	600 W ELV, 120 V
MRF2S-6ND-120-XX	600 W/VA incandescent/halogen/MLV, 120 V 1-8 Lutron LTE drivers, 350W max
MA-R-XX	Accessory dimmer for multi-location lighting controls, 120V

Switch/Dimmers

* (XX in the model number represents color/finish code; use WH for White; please visit lutron.com for other color choices.)



**Maestro Wireless
0-10V Dimmer Sensor**

Dimensions

- W:** 2.94" (75mm)
- H:** 4.69" (119mm)
- D:** 1.44" (38mm)

Features and benefits

- Easy to install; directly replaces an existing control in a wallbox
- Combines occupancy sensing, manual control, and system connectivity in one piece of hardware
- Easily add additional wall controls and sensors without running any new wires
- Connect to a Vive wireless hub for system features such as timeclock, energy reporting, and demand response/load shed
- Lutron XCT technology for superior sensitivity prevents false ons and false offs

How to design and specify

- Select one dimmer or switch per lighting zone
- Select appropriate model based on type of load:
 - 120 – 277V~ 8 A Electronic fluorescent ballast or LED drivers
 - Controls up to 50mA of 0-10V fixtures, sink only (0-10V Dimmer version)
 - Neutral required
- Add additional Pico remotes for rooms with multiple switches for a single zone
- Add additional wireless occupancy and/or daylight sensors for additional coverage area and functionality

Product options

Standard

MRF2S-8SD010-XX	0-10V Wallbox Occupancy/Vacancy Sensor Dimmer
MRF2S-8SS-XX	Wallbox Occupancy/Vacancy Sensor Switch
MRF2S-8SDV010-XX	0-10V Wallbox Vacancy Sensor Dimmer
MRF2S-8SSV-XX	Wallbox Vacancy Sensor Switch

(XX in the model number represents color/finish code)

Sensor coverage diagrams

NEMA WD7 Test Grid Coverage

(High Sensitivity Setting)

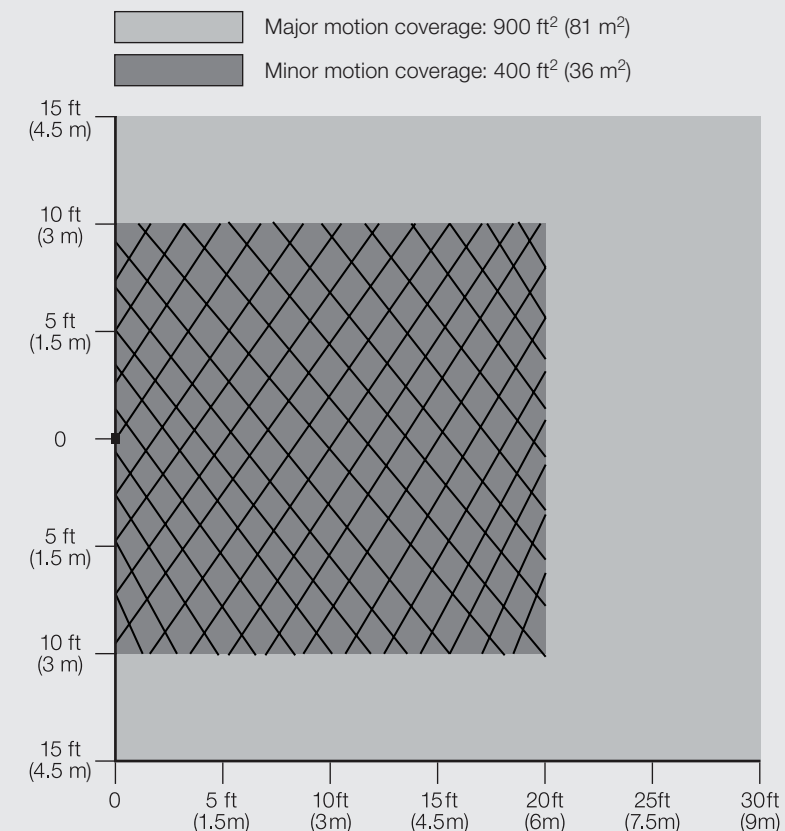

Horizontal Beam Diagram

(For Reference Only)

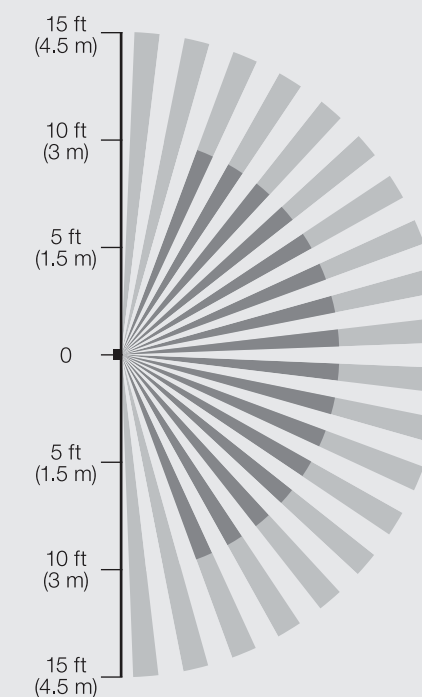

Vertical Beam Diagram

(For Reference Only)

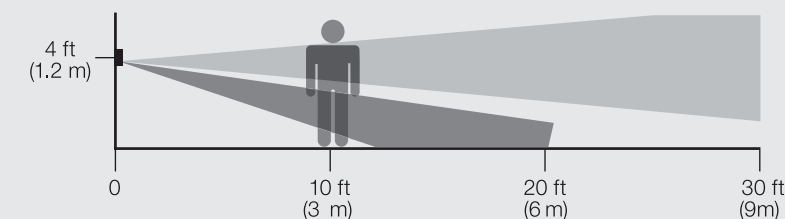



Pico wireless remotes

3-button with raise/lower 3-button 3-button nightlight with raise/lower



2-button with raise/lower 2-button 2-button nightlight

Dimensions

W: 1.28" (33mm)
H: 2.60" (66mm)
D: 0.33" (8mm)

How to design and specify

- Select one 2-button Pico wireless remote to add a location with ON/OFF control
- Select one 3-button Pico wireless remote to add a location with ON/OFF control and one preset
- Select one 2-button with raise/lower Pico wireless remote to add a location with ON/OFF and BRIGHTEN/DIM control
- Select one 3-button with raise/lower Pico wireless remote to add a location with ON/OFF, BRIGHTEN/DIM control and one preset
- Select whether a nightlight is needed (2-button and 3-button with raise/lower only)

Note: Spaces with a PowPak relay or dimming module will not have a local control in the room unless a Pico is added

Product options

2-button remotes

PJ2-2BRL-XXX-L01	2-button with raise/lower wireless remote
PJ2-2B-XXX-L01	2-button wireless remote
PJN-2B-GXX-L01	Nightlight 2-button wireless remote

3-button remotes

PJ2-3BRL-XXX-L01	3-button with raise/lower wireless remote
PJ2-3B-XXX-L01	3-button wireless remote
PJN-3BRL-GXX-L01	Nightlight 3-button with raise/lower wireless remote

How it works

- No wires—put it where it's most accessible
- Pedestal mount for tabletop use
- Surface mount anywhere with Claro wallplate
- 10-year battery life

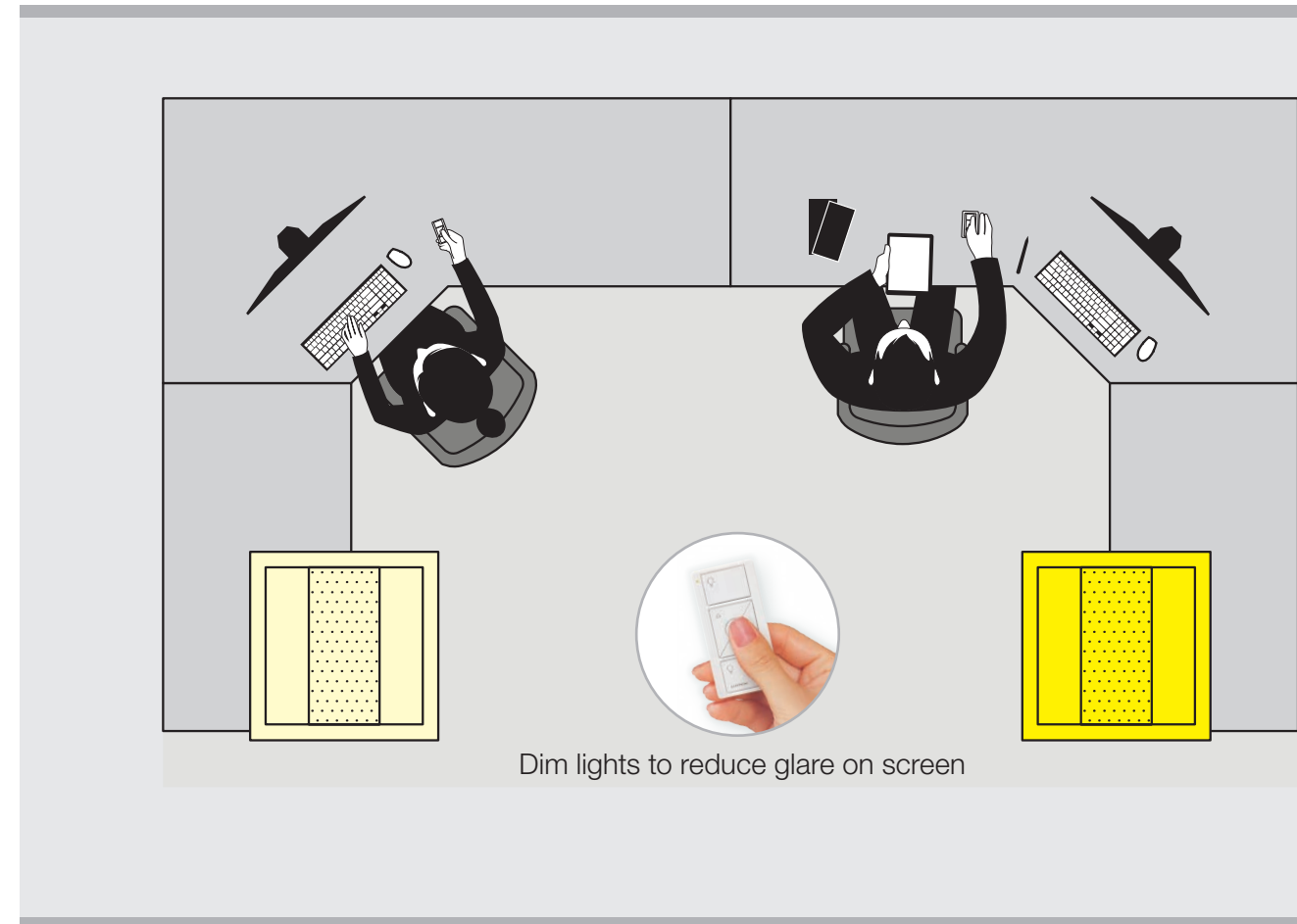

Pico wall mounted (in a wallplate) — Add a new point of control anywhere with absolutely no wires



Raise lights for reading visibility

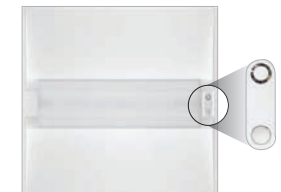

Individual fixture control

Pico remote

(XX in the model number represents color/finish code)



Pico wireless remotes

- 4-button 2-group control
- 4-button zone control
- 4-button scene control

Dimensions

- W:** 1.28" (33mm)
- H:** 2.60" (66mm)
- D:** 0.33" (8mm)

How to design and specify

- The Pico wireless remote is a flexible and easy-to-use device that allows the user to control Lutron wireless load-control devices from anywhere in the space. This battery-operated control requires no external power or communication wiring.

Product options

4-button remotes

PJ2-4B-GWH-L21P	2-group control
PJ2-4B-GWH-L01	Zone control
PJ2-4B-GWH-L31	Scene control

- Custom-engraved models for Zone control keypads (-L01, -S01) and Scene control keypads (-L31, -S31) are available but require a different set of button marking codes when ordering

Note: 2-Group (-L21, -S21, -LS21) controls are not offered with the custom engraving option).

Button Marking Codes	Standard Engraving	Custom Engraving
Zone Control		
Lights	-L01	-EL1
Shades	-S01	-ES1
Scene Control		
Lights	-L31	-EL2
Shades	-S31	-ES2



Tabletop accessories



Wall-mount accessories

Pico wallplate adapter and Claro wallplate

Dimensions

- W:** 2.94" (75mm)
- H:** 4.69" (119mm)
- D:** 1.44" (38mm)

How to design and specify

- Select one Pico pedestal for each tabletop location based on the number of Pico remotes at each location

Product options

Tabletop accessories

L-PED1-WH	pedestal for one Pico remote
L-PED2-WH	pedestal for two Pico remotes
L-PED3-WH	pedestal for three Pico remotes
L-PED4-WH	pedestal for four Pico remotes

How to design and specify

- Select one Pico wallbox adapter for each Pico that you would like wall mounted with a Claro-style wallplate
- Select one Claro wallplate (up to 4-gang) for all Pico and Maestro Wireless wall-mounted control locations where Claro style is desired

Product options

Wall-mount accessories

PICO-WBX-ADAPT	Pico wallbox adapter
CW-1-WH	Claro 1-gang wallplate
CW-2-WH	Claro 2-gang wallplate
CW-3-WH	Claro 3-gang wallplate
CW-4-WH	Claro 4-gang wallplate



Wireless occupancy/vacancy sensors

Dimensions

W: 3.57" (91 mm)
 H: 3.57" (91 mm)
 D: 1.13" (29 mm)

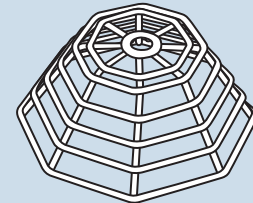

Wire cage guard

Dimensions

W: 7.0" (178 mm)
 D: 3.25" (83 mm)

How to design and specify

- A single occupancy sensor can communicate to all control devices in the room
- Use in small rooms or areas with medium to high partitions
- For 8 ft ceilings: 484 ft²
- For 12 ft ceilings: 676 ft²

Product options

Ceiling-mount sensors

LRF2-OCR2B-P-WH Occupancy/vacancy

LRF2-VCR2B-P-WH Vacancy only

Accessories

L-CMDPIRKIT Ceiling-mount sensor lens masking kit

L-CRMK-WH Ceiling-mount sensor recess-mounting bracket

L-WIRECAGE-C Wire guard for ceiling-mount sensor

Sensor coverage diagrams

Ceiling mount, 360°

Floor view

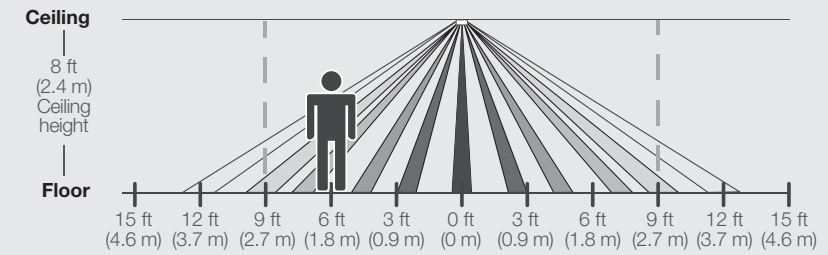

Coverage varies by ceiling height

Key:

- Minor motion
- Major motion

Top view

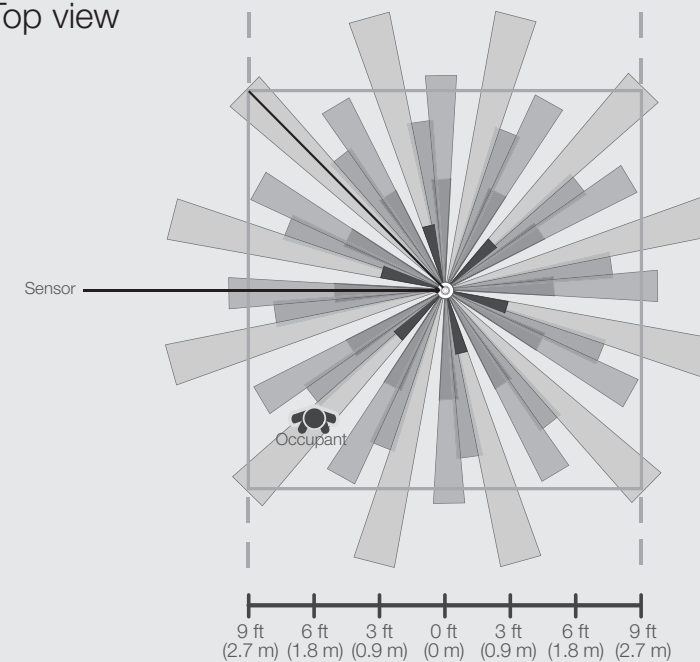

Ceiling-mount sensor coverage chart (for sensor mounted in center of room)

Ceiling height	Maximum room dimensions for complete floor coverage	Radius of coverage at floor
8 ft (2.4 m)	18 x 18 ft (5.5 x 5.5 m) 324 ft ² (30.2 m ²)	13 ft (4.0 m)
9 ft (2.7 m)	20 x 20 ft (6.1 x 6.1 m) 400 ft ² (37.2 m ²)	14.5 ft (4.4 m)
10 ft (3.0 m)	22 x 22 ft (6.7 x 6.7 m) 484 ft ² (44.9 m ²)	16 ft (4.9 m)
12 ft (3.7 m)**	26 x 26 ft (7.9 x 7.9 m) 676 ft ² (62.4 m ²)	19 ft (5.8 m)

* Sensor mounting shown at 7 ft (2.1 m). Mounting height should be between 6 and 8 ft (1.6 and 2.4 m).

** 12 ft (3.7 m) is the maximum mounting height allowed.



Radio Powr Savr wireless sensors

Dimensions

W: 1.8" (46mm)
 H: 4.35" (110mm)
 D: 1.35" (34mm)



Flexible armature mounting kit

Dimensions

W: 3.62" (92mm)
 H: 2.18" (55mm)

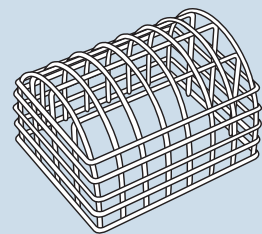

Wire cage guard

Dimensions

W: 7.0" (178mm)
 H: 5.75" (146mm)
 D: 4.5" (114mm)

How to design and specify

- A single occupancy sensor can communicate to all control devices in the room

Product options

Wall-mount sensors

- Use in large open rooms with few tall obstructions
- Coverage: 3,000 ft²

LRF2-OWLB-P-WH Occupancy/vacancy

LRF2-VWLB-P-WH Vacancy only

Corner-mount sensors

- Use in medium to large open rooms with few tall obstructions
- Coverage: 2,500 ft²

LRF2-OKLB-P-WH Occupancy/vacancy

LRF2-VKLB-P-WH Vacancy only

Hallway sensors

- For a 6 ft wide hallway: 50 ft coverage
- For a 10 ft wide hallway: 150 ft coverage

LRF2-OHLB-P-WH Occupancy/vacancy

LRF2-VHLB-P-WH Vacancy only

Accessories

LRF-ARM-WH Flexible armature mounting kit for Radio Powr Savr wall, hall, corner sensors

L-WIRECAGE-C Wire guard for ceiling-mount sensor

L-WIRECAGE-W Wire guard for in-wall sensor

Sensor coverage diagrams

Wall mount*, 180°

1,500 ft²—minor motion
 3,000 ft²—major motion

Top view

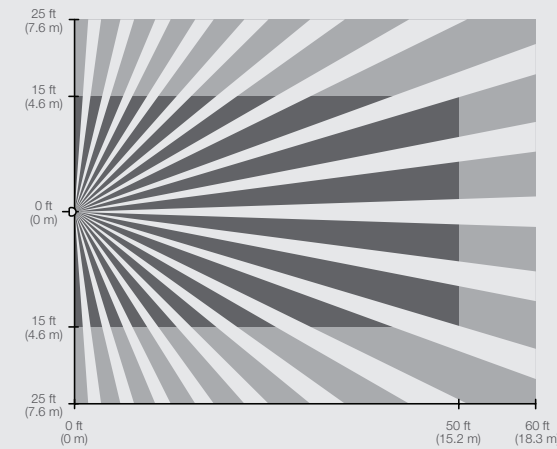

Corner mount*, 90°

1,225 ft²—minor motion
 2,500 ft²—major motion

Top view

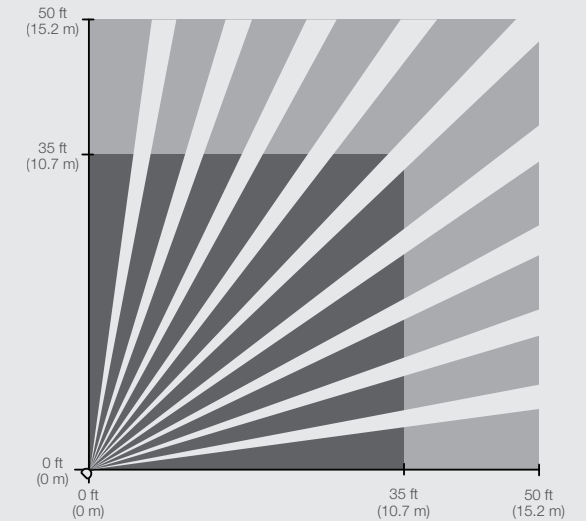

Key:

- Minor motion
- Major motion

Hallway*, long narrow field of view

Coverage varies by hallway width and length

Top view

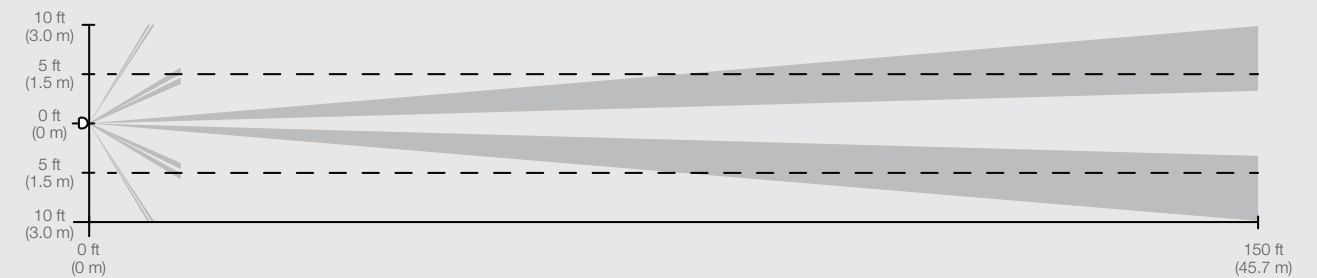

Hallway sensor maximum recommended length chart (sensor centered within hallway)

Width of hallway	Length of hallway
6 ft (1.6 m) or less	50 ft (15.2 m)
8 ft (2.4 m)	100 ft (30.5 m)
10 ft (3.0 m) or more	150 ft (45.7 m)

* Sensor mounting shown at 7 ft (2.1 m). Mounting height should be between 6 and 8 ft (1.6 and 2.4 m).
 ** 12 ft (3.7 m) is the maximum mounting height allowed.



Wireless daylight sensors

Dimensions

- W:** 1.6" (41 mm)
- H:** 1.6" (41 mm)
- D:** 0.7" (17 mm)

How to design and specify

- A single daylight sensor is capable of controlling:
 - All Maestro switching and dimming zones
 - All PowPak switching zones
 - All PowPak dimming modules with 0-10V control

Product options

Daylight sensor

LRF2-DCRB-WH	Daylight sensor
---------------------	-----------------

- * Sensor mounting shown at 7 ft (2.1 m). Mounting height should be between 6 and 8 ft (1.6 and 2.4 m).
- ** 12 ft (3.7 m) is the maximum mounting height allowed.

Sensor coverage diagrams

Location for average size areas

Arrow points towards the area viewed by the sensor (towards windows).

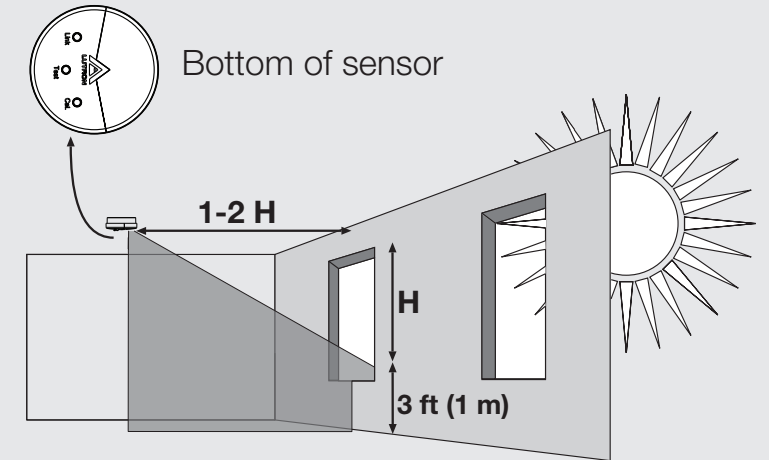

H = Effective Window Height

Location for narrow areas (corridors, private offices)

Arrow points towards the area viewed by the sensor (away from window).

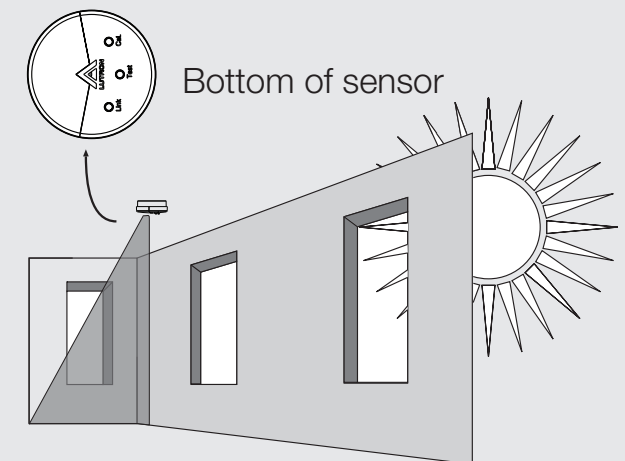



Setup support services

- 4- & 8-Hour onsite blocks
- 4-Hour remote blocks
- Additional setup support services

Available setup support services

Blocks of setup support time

- Lutron Services Representative — either onsite or remotely — supports the installation team in setting up the system
- Utilize the technician’s time in the way that best suits your needs: training, punch list items, or complete programming independently
- Mix and match remote and onsite blocks of time and use them when you need them during the construction timeline
- Choose the amount of time you need

Product options

Blocks of setup support time

LSC-OS-PROG8-SP 8 hours of onsite setup support

LSC-OS-PROG4-SP 4 hours of onsite setup support

LSC-RMT-PROG4-SP 4 hours of remote setup support

Additional setup support services

available with blocks and startup

LSC-PREWIRE Prewire visit

LSC-TRAINING Customer-site solution training

LSC-AF-VISIT Onsite scene and level tuning

LSC-WALK Onsite performance—
verification walk-through



Full-scope startup

- Onsite
- Remote

Available startup services

Onsite full-scope startup

- Lutron Service Representative onsite to ensure proper system startup and configuration
- Train facilities staff to best utilize and maintain the lighting control assets
- Reduce risk and keep your Installation team small by having us do the setup for you.
- Includes a Commercial System Limited Warranty
- Onsite startup enhancements available

Remote full-scope startup

- Dedicated Lutron Remote Technician works with your installation team to ensure proper system startup and configuration
- Introduce end-user facilities staff to system components and resources available
- Less lead time to schedule than onsite startup
- Lower cost than onsite startup
- Commercial system limited warranty available

Product options

Setup service models

Full scope startup

LSC-OS-SU-VIVE Onsite full-scope startup

LSC-RMT-SU-VIVE Remote full-scope startup

Startup enhancements (Available with onsite full-scope startup)

LSC-AH-SU Startup performed at night or weekends (weekend work available in certain locations)

LSC-SENS-LT Sensor layout & tuning

LSC-SPV-DOC System performance—
verification documentation

LSC-SPV-DOC-T24 Title 24 acceptance test visit



Operational services

- Solution training
- System optimization
- Onsite reconfiguration
- Remote reconfiguration

Available Operational Services

- Support the facilities team to maximize system potential
- Reprogram the system as space needs change over time
- Support retro-commissioning requirements
- Pre-purchase with the system to capture costs in capital budget

Product options

Operational service models

Operational services

LSC-TRAINING	Customer-site solution training
LSC-SYSOPT	System optimization service
LSC-OS-PROG8-EN	8 hours of onsite reconfiguration support
LSC-OS-PROG4-EN	4 hours of onsite reconfiguration support
LSC-RMT-PROG4-EN	4 hours of remote reconfiguration support

Remote and onsite services are also available for purchase after the system is in operation at hourly, half-day and full-day rates; contact Lutron at lscwarranty@lutron.com for more information.



Commercial system limited warranty

The commercial system limited warranty offers 5 years of parts coverage, 2 years of first-available onsite/remote response time for system issues, and 24/7 technical support. *Warranty included with onsite full-scope startup & available with remote full-scope startup*

Product options

Vive limited warranty

LSC-B2	Commercial System 2-Year Limited
---------------	-------------------------------------

Technology Support Plans (TSPs)

All Lutron Technology Support Plans provide 100% parts and diagnostic labor coverage for up to 10 years. Optional response-time guarantees and preventive maintenance visits enable the coverage to be customized to meet the facility's needs. TSPs are available for any Vive system; a warranty audit visit will be included with the purchase of a TSP when full-scope startup is not purchased.

Product options

Vive Technology Support Plans

LSC-SILV-IW	Silver Level Technology Support Plan
LSC-GOLD-IW	Gold Level Technology Support Plan
LSC-PLAT-IW	Platinum Level Technology Support Plan
LSC-WARR-AUD	Warranty Audit Visit

Note: For detailed warranty and technology support plan descriptions see lutron.com/services

Vive warranty information

Vive wireless solutions are all covered by a 5-year parts warranty with registration of the product. Additional technology support options are available to meet your project needs. See the options below.

Support Options	Commercial System Limited Warranty	Silver (TSP)	Gold (TSP)	Platinum (TSP)
Duration up to 10 years of coverage		•	•	•
100% Replacement Parts	• (5 yrs)	•	•	•
Diagnostic Labor – First Available Response	• (2 yrs)	•		
Diagnostic Labor – 72-Hour Response			•	
Diagnostic Labor – 24-Hour Response				•
Annual Preventive Maintenance Visit			•	•



Model Number	Description	List Price (US)
Vive wireless hub		
H-MOUNT-SM	Surface-mount installation adapter	80.00
HJS-0-FM	Starter Vive wireless hub, flush mount	1,700.00
HJS-1-FM	Standard Vive wireless hub, flush mount	Contact Lutron sales for a quote
HJS-1-SM	Standard Vive wireless hub, surface mount	
HJS-2-FM	Premium Vive wireless hub, flush mount	
HJS-2-SM	Premium Vive wireless hub, surface mount	

Vive Vue Dashboard Software		
VIVE-VUE	Vive Vue Software Dashboard License	Contact Lutron sales for a quote
HJS-UPDATE	Software upgrade license to add BACnet and API	
HJS-DEVICES	Software upgrade license expands device limit to 700 devices	



PowPak relay module		
RMJS-5R-DV-B	5A relay	111.00
RMJS-5RCCO1-DV-B	5A relay with one contact closure output	126.00
RMJS-16R-DV-B	16A relay	131.00
RMJS-16RCCO1DV-B	16A relay with one contact closure output	146.00



PowPak dimming module		
RMJS-8T-DV-B	8A 0-10V controller-connector	152.00
RMJS-8TN-DV-B	8A 0-10V controller-flying leads	152.00
RMJS-ECO32-SZ	Single zone EcoSystem/DALI controller	152.00



RMJS-PNE-DV	Phase Select dimming module	240.00
RMJS-5T-347	5A 0-10V dimmer for 347V	180.00
5T-347-DIVIDER	Divider for class 1 & class 2 separation	9.00

PowPak contact closure output module		
RMJS-CCO1-24-B	one contact closure output	111.00



Model Number	Description	List Price (US)
PowPak relay module		
RMJS-20R-DV-B	20A Receptacle Control Relay Module	141.00
RMJS-20RCCO1DV-B	20A Receptacle Control Relay Module with contact closure output	156.00

Wireless Receptacle		
CAR2S-15-STR	15A Split (half switching; single pole/downstream, 120V)	173.00
CAR2S-15-DTR	15A Duplex (dual switching; single pole/downstream, 120V)	173.00
CAR2S-20-STR	20A Split (half switching; single pole/downstream, 120V)	193.00
CAR2S-20-DTR	20A Duplex (dual switching; single pole/downstream, 120V)	193.00

Individual fixture control		
FCJS-010	0-10V Control Module	79.00
FCJS-ECO	EcoSystem Control Module	79.00
FCJS-010-BULK8	0-10V Control Module 8-pack	610.00
FCJS-ECO-BULK8	EcoSystem Control Module 8-pack	610.00
FC-SENSOR	Occupancy/Daylight Sensor	35.00
FC-VSENSOR	Vacancy/Daylight Sensor	35.00
DFCSJ-OEM-RF*	Vive Integral Fixture Control (RF Only)	60.00
DFCSJ-OEM-OCC*	Vive Integral Fixture Control (with Sensing)	70.00

UL 924 rated emergency wireless load controllers		
RMJS-16R-DV-B-EM	Emergency rated 16A relay	182.00
RMJS-8T-DV-B-EM	Emergency rated 8A, 0-10V dimmer	203.00
FCJS-ECO-EM	Emergency rated EcoSystem control module	128.00
FCJS-010-EM	Emergency rated 0-10V control module	130.00
RMJS-PNE-DV-EM	Emergency rated Phase Select dimming module	280.00
RMJS-5T-347-EM	Emergency rated 5A, 0-10V controller for 347V	235.00

* Contact your local fixture representative and ask for a Vive-enabled fixture or visit lutron.com/findafixture Fixture adders may vary.



Model Number Description List Price (US)

Maestro Wireless switches*

MRF2S-6ANS-XX	6 A lighting, 3A fan (1/10HP motor), 120V	110.00
MRF2S-8S-DV-XX	8A lighting, 3A fan (1/10HP motor, 120V only), spec grade	173.00
MRF2S-8ANS-120-XX	8A lighting, 5.8A fan (1/4HP motor), spec grade, 120V	142.00

Maestro Wireless dimmers*

MRF2S-6CL-XX	150W dimmable CFL/LED, 600W incandescent, halogen	110.00
MRF2S-6ELV120-XX	600W ELV, 120V	212.00
MRF2S-6ND-120-XX	600W/VA incandescent/halogen/MLV, 120 V	152.00
MRF2S-8SD010-XX	0-10V Wallbox Dimmer Sensor	180.00
MRF2S-8SS-XX	Wallbox Sensor Switch	160.00

Maestro Wireless/Maestro occupancy sensing control companion devices*

MA-AS-XX	Multi-location companion switch, 120V	39.70
MA-R-XX	Multi-location companion dimmer, 120V	31.50

* (XX in the model number represents color/finish code; use WH for White; please visit lutron.com for other color choices.) Price indicated for gloss finish products.

Maestro Colors

Gloss Colors

- S White (WH)
- S Ivory (IV)
- S Almond (AL)
- S Light Almond (LA)
- S Gray (GR)
- S Brown (BR)
- S Black (BL)

Satin Colors (Prices vary from Gloss Colors)

- Hot (HT)
- Merlot (MR)
- Plum (PL)
- Midnight (MN)
- Sienna (SI)
- Terracotta (TC)
- Greenbriar (GB)
- Bluestone (BG)
- Taupe (TP)
- Eggshell (ES)
- Biscuit (BI)
- Snow (SW)
- Palladium (PD)
- Mocha Stone (MS)
- Goldstone (GS)
- Desert Stone (DS)
- Stone (ST)
- Limestone (LS)



Model Number Description List Price (US)

Pico wireless remotes*

PJ2-2BRL-XXX-L01	2-button with raise/lower	25.00
PJ2-2B-XXX-L01	2-button	25.00
PJN-2B-GXX-L01	Nightlight 2-button	58.00
PJ2-3BRL-XXX-L01	3-button with raise/lower	21.00
PJ2-3B-XXX-L01	3-button	25.00
PJN-3BRL-GXX-L01	Nightlight 3-button with raise/lower	58.00
PJ2-4B-XXX-L21	4-button with 2 group control	39.00
PJ2-4B-XXX-L01	4-button with zone control	25.00
PJ2-4B-XXX-L31	4-button with scene control	39.00

* (XX in the model number represents color/finish code; price shown is for white (WH) models only.) Price for other colors varies.

Pico accessories*

PICO-WBX-ADAPT	Pico wireless remote wallbox adapter	8.90
PICO-347WBX-ADAP	Pico wireless remote wallbox adapter for 347V	9.00
CW-1-XX	Claro 1-gang wallplate	5.00
CW-2-XX	Claro 2-gang wallplate	10.00
CW-3-XX	Claro 3-gang wallplate	15.20
CW-4-XX	Claro 4-gang wallplate	21.00
L-PED1-XX**	Pico wireless remote single pedestal	15.00
L-PED2-XX**	Pico wireless remote double pedestal	30.00
L-PED3-XX**	Pico wireless remote triple pedestal	100.00

* (XX in the model number represents color/finish code; use WH for White; please visit lutron.com for other color choices.) Price indicated for gloss finish products.

** (XX in the model number represents color/finish code; use WH for White; please visit lutron.com for other color choices.) Price indicated for White finish products.

Pico Colors

Gloss Colors

- White (WH)
- Ivory (IV)
- Light Almond (LA)

- White/Gray (WG)
- Black (BL)

Satin Colors

- Snow (SW)
- Biscuit (BI)
- Midnight (MN)

* \$56 not in white

Model Number Description List Price (US)

Radio Powr Savr occupancy/vacancy sensors*



LRF2-OCR2B-P-WH	Ceiling-mount, 360° field-of-view, occupancy/vacancy sensor	89.00
LRF2-OWLB-P-WH	Wall-mount, 180° field-of-view, occupancy/vacancy sensor	89.00
LRF2-OKLB-P-WH	Corner-mount, 90° field-of-view, occupancy/vacancy sensor	89.00
LRF2-OHLB-P-WH	Hallway, occupancy/vacancy sensor	89.00

Occupancy/vacancy sensor accessories



L-CMDPIRKIT	Sensor lens masking kit for Radio Powr Savr ceiling sensor	12.50
L-CRMK-WH	Recess-mounting bracket for Radio Powr Savr ceiling sensor	18.00
LRF-ARM-WH	Flexible armature mounting kit for Radio Powr Savr wall, hall, corner sensors	62.00
L-WIRECAGE-WBX	Wire guard for in-wall sensor, White	68.00
L-WIRECAGE-C	Wire guard for ceiling-mount sensor, White	68.00
L-WIRECAGE-W	Wire guard for wall-mount and hallway sensors, White	68.00

Radio Powr Savr daylight sensor



LRF2-DCRB-WH	Ceiling-mount daylight sensor	125.00
--------------	-------------------------------	--------

Wallplates*



CW-1-XX	Claro 1-gang wallplate	5.00
CW-2-XX	Claro 2-gang wallplate	10.00
CW-3-XX	Claro 3-gang wallplate	15.20
CW-4-XX	Claro 4-gang wallplate	21.00

* (XX in the model number represents color/finish code; use WH for White; please visit lutron.com for other color choices.) Price indicated for gloss finish products.

Model number Description List Price (US)

Vive Startup Services



LSC-OS-SU-VIVE	Onsite full-scope startup	Contact Lutron sales for a quote
LSC-RMT-SU-VIVE	Remote full-scope startup	
LSC-AH-SU	After hours startup	
LSC-SENS-LT	Sensor layout & tuning	
LSC-SPV-DOC	System performance-verification documentation	
LSC-SPV-DOC-T24	Title 24 acceptance test visit	

Vive Setup Support Services



LSC-OS-PROG8-SP	Onsite programming — 8-hour block	Contact Lutron sales for a quote
LSC-OS-PROG4-SP	Onsite programming — 4-hour block	
LSC-RMT-PROG8-SP	Remote programming — 8-hour block	
LSC-PREWIRE	Prewire visit	
LSC-TRAINING	Customer-site solution training	
LSC-AF-VISIT	Onsite scene and level tuning	
LSC-WALK	Onsite performance-verification walkthrough	

Vive Operational Services



LSC-TRAINING	Customer-site solution training	Contact Lutron sales for a quote
LSC-SYSOPT	System optimization service	
LSC-OS-PROG8-EN	8 hours of onsite reconfiguration support	
LSC-OS-PROG4-EN	4 hours of onsite reconfiguration support	
LSC-RMT-PROG4-EN	4 hours of remote reconfiguration support	

Vive Limited Warranty and Technology Support Plans

LSC-B2	Commercial system limited warranty	Contact Lutron sales for a quote
LSC-SILV-IW	Silver level technology support plan	
LSC-GOLD-IW	Gold level technology support plan	
LSC-PLAT-IW	Platinum level technology support plan	
LSC-WARR-AUD	Warranty audit visit	

Other energy saving devices by Lutron

These devices do not integrate with the Vive system

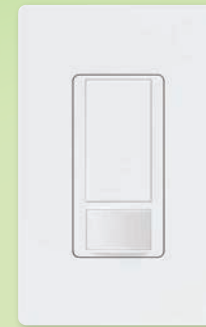

Maestro sensor

Dimensions

W: 2.94" (75 mm)
H: 4.69" (119 mm)
D: 1.44" (38 mm)



Maestro dual-circuit sensor switch

Dimensions

W: 2.94" (75 mm)
H: 4.69" (119 mm)
D: 1.44" (38 mm)

* (XX in the model number represents color/finish code; use WH for White; please visit lutron.com for other color choices.) See Maestro colors on page 51.

† Vacancy-only models available. Replace the "O" in the model number with a "V".

Features and benefits

- **Standalone solutions are not compatible with the Vive hub**
- Lutron XCT technology for superior sensitivity prevents false ons and false offs
- Automatically turns lights off when space is unoccupied
- Easy to install; directly replaces an existing control
- Lutron's Smart Ambient Light Detection learns your preferences over time and adapts accordingly
- Lutron's Adaptive Zero-Cross Switching extends relay lifetime
- 180° sensor field-of-view; must have unobstructed view
- Up to 900 ft² major motion coverage and 400 ft² minor motion coverage
- Adjustable timeout—1, 5, 15, 30 minutes
- Vacancy/partial-on models available to meet CA Title 24 requirements
- Dual-circuit sensors provide bi-level control of two circuits, as required by specific energy codes
- Select from up to 27 colors to complement the décor*

Product options

Maestro sensor switch[†]

MS-OPS2-XX	2 A lighting, 120V PIR occupancy/vacancy; single pole, no neutral
MS-OPS5M-XX	5 A lighting, 120V PIR occupancy/vacancy; 3 A fan, multi-location/3-way/single pole, no neutral
MS-OPS6M2-DV-XX	6 A lighting, 120-277V PIR occupancy/vacancy, 3 A fan (120V only); no neutral
MS-OPS6M2N-DV-XX	6 A lighting, 120-277V PIR occupancy/vacancy, 3 A fan (120V only); neutral required

Maestro dual-circuit sensor switch

MS-OPS6-DDV-XX	6 A lighting per circuit, 120-277V PIR dual-circuit occupancy/vacancy; 4.4 A fan (120V only) per circuit; single pole
-----------------------	---



Maestro dual-technology sensor switch

Dimensions

W: 2.94" (75mm)
H: 4.69" (119mm)
D: 1.44" (38mm)



Maestro dual-technology, dual-circuit sensor switch

Dimensions

W: 2.94" (75mm)
H: 4.69" (119mm)
D: 1.44" (38mm)

Features and benefits

- **Standalone solutions are not compatible with the Vive hub**
- Lutron XCT technology greatly enhances the performance of dual-technology sensors, enabling them to detect very fine motion like typing
- Automatically turns lights off when space is unoccupied
- Easy to install; directly replaces an existing control
- Lutron's Smart Ambient Light Detection learns your preferences over time and adapts accordingly
- Lutron's Adaptive Zero-Cross Switching extends relay lifetime
- 180° sensor field-of-view; must have unobstructed view
- Up to 900 ft² major motion coverage and 400 ft² minor motion coverage
- Adjustable timeout—1, 5, 15, 30 minutes
- Vacancy models available to meet CA Title 24 requirements
- Dual-circuit sensors provide bi-level control of two circuits, as required by specific energy codes
- Select from up to 27 colors to complement the décor*

Product options

Maestro sensor switch[†]

MS-A102-XX	6A lighting, 120-277V dual-tech occupancy/vacancy sensor, 4.4A fan (120V only); single pole, no neutral
MS-B102-XX	6A lighting, 120-277V dual-tech occupancy/vacancy sensor, 4.4A fan (120V only); multi-location/3-way, neutral required

Maestro dual-circuit sensor switch

MS-A202-XX	6A lighting per circuit, 120-277V dual-tech occupancy/vacancy, 4.4A fan (120V only) per circuit; single pole, no neutral
MS-B202-XX	6A lighting per circuit, 120-277V dual-tech occupancy/vacancy sensor, 4.4A fan (120V only) per circuit; 3-way, neutral required

* (XX in the model number represents color/finish code; use WH for White; please visit lutron.com for other color choices.) See Maestro colors on page 51.

† Vacancy only models available. Add "-V-" before the color code (XX).



In-wall PIR occupancy/vacancy sensor switches

Dimensions

W: 2.94" (75mm)
H: 4.69" (119mm)
D: 1.44" (38mm)

Features and benefits

- **Standalone solutions are not compatible with the Vive hub**
- Lutron XCT technology for superior sensitivity prevents false ons and false offs
- Automatically turns lights off when space is unoccupied
- Easy to install; directly replaces an existing control
- Lutron's Smart Ambient Light Detection learns your preferences over time and adapts accordingly
- 180° sensor field-of-view; must have unobstructed view
- Up to 900 ft² major motion coverage and 400 ft² minor motion coverage
- Adjustable timeout—1, 5, 15, 30 minutes
- Vacancy models available to meet CA Title 24 requirements
- Select from up to 27 colors to complement the décor*

Product options

0-10 V dimmer sensor[†]

MS-Z101-XX	8A lighting 120-277V; occupancy/vacancy; multi-location/3-way/single pole
-------------------	---

Controls electronic LED drivers and fluorescent ballasts

- Miswire and load incompatibility alert — lens will flash red if control is miswired or connected to an incompatible fixture
- Selectable dimming curve optimizes performance of 0-10V LED drivers
- Lutron's Adaptive Zero-Cross Switching extends relay lifetime

* (XX in the model number represents color/finish code; use WH for White; please visit lutron.com for other color choices.) See Maestro colors on page 51.

† Vacancy-only models available. Replace the "O" in the model number with a "V".



C-L dimmer sensor†

Dimensions

W: 2.94" (75mm)
H: 4.69" (119mm)
D: 1.44" (38mm)

Features and benefits

- Standalone solutions are not compatible with the Vive hub
- C-L dimmer for control of screw-based CFLs and LEDs

Product options

C-L dimmer sensor†

MSCL-OP153M-XX	C-L dimmer with PIR sensor; occupancy/vacancy; multi-location/3-way/single pole; 150W CFL/LED, 600W incandescent/halogen
-----------------------	--

* (XX in the model number represents color/finish code; use WH for White; please visit lutron.com for other color choices.) See Maestro colors on page 49.

† Vacancy-only models available. Replace the "O" in the model number with a "V".

‡ For dual-tech or 0-10 V vacancy models, Add "-V-" before the color code (XX).

Sensor coverage diagrams

In-wall

PIR beam diagram
(for reference only)

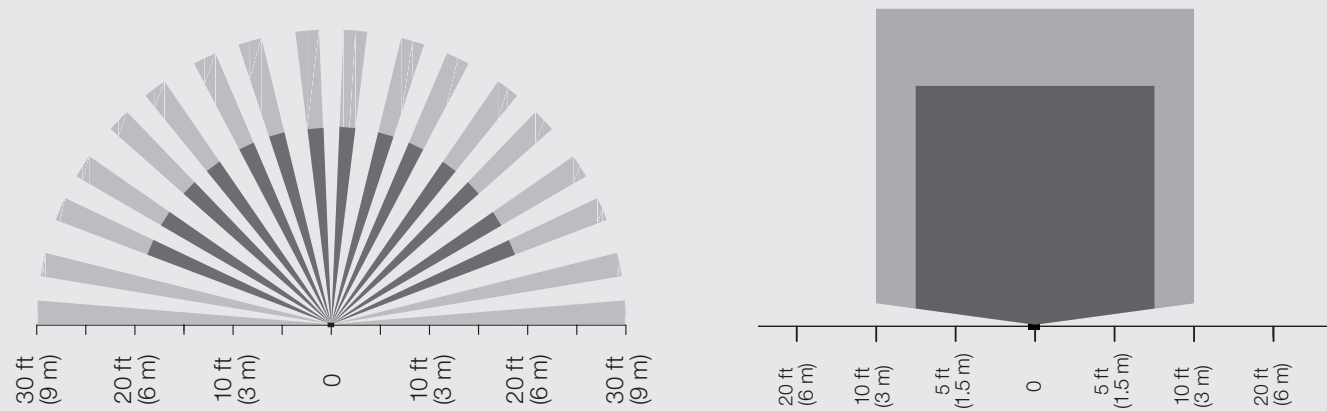

* Sensor mounting shown at 7 ft (2.1 m). Mounting height should be between 6 and 8 ft (1.6 and 2.4 m).



Model number	Description	List Price (US)
--------------	-------------	-----------------

Sensor switches*

MS-OPS2-XX	2A lighting, 120V PIR occupancy/vacancy; single pole, no neutral	29.90
MS-OPS5M-XX	5A lighting, 120V PIR occupancy/vacancy; 3A fan, multi-location/3-way/single pole, no neutral	42.80
MS-OPS6M2-DV-XX	6A lighting, 120-277V PIR occupancy/vacancy, 3A fan (120V only); no neutral	55.00
MS-OPS6M2N-DV-XX	6A lighting, 120-277V PIR occupancy/vacancy, 3A fan (120V only); neutral required	53.00
MS-OPS6M2U-DV-XX	6A lighting, 120-277V PIR occupancy/vacancy, 3A fan (120V only); configurable ground or neutral wire	54.00

Dual-circuit sensor switches*

MS-OPS6-DDV-XX	6A lighting per circuit, 120-277V PIR dual-circuit occupancy/vacancy; 4.4A fan (120V only) per circuit; single pole	92.00
MS-PPS6-DDV-XX	6A lighting per circuit, 120-277V PIR dual-circuit partial-on occupancy/vacancy, 4.4A fan (120V only) per circuit; single pole	92.00

Dual-technology sensor switches**

MS-A102-XX	6A lighting, 120-277V dual-tech occupancy/vacancy sensor, 4.4A fan (120V only); single pole, no neutral	103.00
MS-B102-XX	6A lighting, 120-277V dual-tech occupancy/vacancy sensor, 4.4A fan (120V only); multi-location/3-way, neutral required	103.00

Dual-technology dual-circuit sensor switches**

MS-A202-XX	6A lighting per circuit, 120-277V dual-tech occupancy/vacancy, 4.4A fan (120V only) per circuit; single pole, no neutral	129.00
MS-B202-XX	6A lighting per circuit, 120-277V dual-tech occupancy/vacancy sensor, 4.4A fan (120V only) per circuit; 3-way, neutral required	129.00

Sensor dimmers**

MS-Z101-XX	8A lighting 120-277V; occupancy/vacancy; multi-location/3-way/single pole	114.00
MSCL-OP153M-XX	C-L dimmer with PIR sensor; occupancy/vacancy; single pole/3-way/multi-location; 150W CFL/LED, 600W incandescent/halogen	56.00

* Vacancy models available to meet California Title 24 section 119(j) requirements.

** For dual-tech or 0-10V vacancy models, add "-V-" before the color code (XX).

lutron.com

Lutron Electronics Co., Inc., 7200 Suter Road, Coopersburg, PA 18036-1299

Customer Assistance

Online: lutron.com/help

Email: support@lutron.com

Phone: 1.844.LUTRON1 (588.7661) — includes 24/7 technical support

© 03/2021 Lutron Electronics Co., Inc. | P/N 367-2597 REV R

